

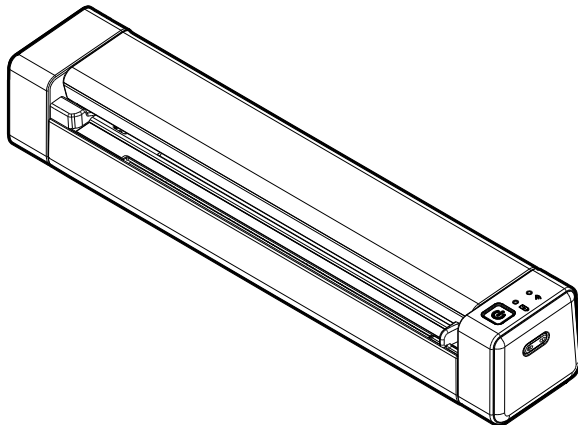

Mobile Scanner

User's Manual



Regulatory model: FF-2111B

Avison Inc.

Trademarks

Microsoft is a U.S. registered trademark of Microsoft Corporation.

Windows 7, Windows 8, Windows 10, and Windows 11 are either registered trademarks or trademarks of Microsoft Corporation in the United States and/or other countries.

Other brands and product names herein are trademarks or registered trademarks of their respective holders.

Copyright

All rights reserved. No part of this publication may be reproduced, transmitted, transcribed, stored in a retrieval system, or translated into any language or computer language, in any form or by any means, electronic, mechanical, magnetic, optical, chemical, manual, or otherwise, without the prior written permission of Avison Inc.

Material scanned by this product may be protected by governmental laws and other regulations, such as copyright laws, the customer is solely responsible for complying with all such laws and regulations.

Warranty

The information contained in this document is subject to change without notice.

Avison makes no warranty of any kind with regard to this material, including, but not limited to, the implied warranties of fitness for a particular purpose.

Avison shall not be liable for errors contained herein or for incidental or consequential damages in connection with the furnishing, performance, or use of this material.

FCC Radio Frequency Interference Statement

This product has been tested and found to comply with the limits for a class B digital device, pursuant to Part 15 of the FCC rules. Operation is subject to the following two conditions: (1) this device may not cause harmful interference, and (2) this device must accept any interference received, including interference that may cause undesired operation. The FCC Class B limits are designed to provide reasonable protection against harmful interference in a residential installation. This equipment generates, uses, and can radiate radio frequency energy and, if not installed and used in accordance with the instructions, may cause harmful interference to radio communications. However, there is no guarantee that interference will not occur in a particular installation. If this equipment does cause harmful interference to radio or television reception, which can be determined by turning the equipment off and on, the user is encouraged to try to correct the interference by one or more of the following measures:

- Reorient or relocate the receiving antenna.
- Increase the separation between the equipment and receiver.
- Connect the equipment into an outlet on a circuit different from that to which the receiver is connected.
- Consult your point of purchase or service representative for additional suggestions.



European Union Regulatory Notice

Products bearing the CE marking comply with the following EU Directives:

- Low Voltage Directive 2014/35/EC
- EMC Directive 2014/30/EC
- Restriction of the use of certain hazardous substances (RoHS) Directive 2011/65/EU
- RED (Radio Equipment Directive) (2014/53/EC)

This product satisfies the Class B limits of EN55032, EN55035, and safety requirements of EN62368-1.

*This machine is certified as Class 1 LED product.

Disposal of Waste Equipment by Users in Private Union



This symbol on the product or on its packaging indicates that the product can not be disposed of with your other household waste. Instead it should be sent to appropriate facilities for recovery and recycling in an effort to protect human health and the environment. For more information about where you can drop off your waste equipment for recycling, please contact your local city office, your household waste disposal service or the shop where you purchased the product.



System Requirements

CPU:	Intel® Core™ 2 Duo or higher
Memory:	32 bit: 2 GB 64 bit: 4 GB
Optical Drive:	DVD-ROM Drive
USB Port:	USB 2.0
Compatible Operating System:	Microsoft Windows 7, Windows 8 (32 bits/64 bits), Windows 10 (32 bits/64 bits)

Product Safety Guide

Please clearly read all these instructions, and follow all instructions and warnings before installing and using the device.

The following indications are used in this document to obviate any chance of accident or damage to you and/or the device.

 WARNING	Indicates potentially hazardous situations, which if instructions are not followed, could result in death or serious injury.
 CAUTION	Indicates a potentially hazardous situation which, if instructions are not followed, may result in minor or moderate injury or damage to property.

WARNING

- Use only the USB cable that came with your device and avoid abrasions, cuts, fraying, crimping, and kinking. Using any other USB cable could cause fire, electrical shock, or injury.
- Place the device close enough to the computer so that the interface cable can easily reach between the device and the computer.
- Do not place or store the device:
 - Outdoors
 - Near excessive dirt or dust, water, or heat sources
 - In locations subject to shocks, vibrations, high temperature or humidity, direct sunlight, strong light sources, or rapid changes in temperature or humidity
- Do not use the device with wet hands.
- Never disassemble, modify, or attempt to repair the device or device option by yourself, except as specifically explained in the device's documentation. This could cause fire, electrical shock, or injury.

- Unplug the device and the USB cable, and refer servicing to qualified service personnel under the following conditions:
 - Liquid has entered the device.
 - Object has entered the device.
 - The device has been dropped, or the case has been damaged.
 - The device does not operate normally (i.e. appearance of smoke, strange smell, odd noise, etc.), or exhibits a distinct change in performance.
- Unplug the device and the USB cable before cleaning.

 **CAUTION:**

- Do not locate the device on rickety or aslope tables. Do not locate the device on unstable surface. The device may fall down and this may result in injury.
- Do not place heavy objects on the unit. It may cause unbalance and the device may fall down. This may result in injury.
- Store the AC Power cord/USB cable bundled out of the reach of children to avoid the risk of injury.
- Keep plastic bags bundled out of the reach of children or throw them away to avoid the danger of suffocation.
- If you are not going to use the device for a long period, unplug the USB cable from the electrical outlet.

FCC Caution:

Any changes or modifications not expressly approved by the party responsible for compliance could void the user's authority to operate this equipment.

This device is intended only for OEM integrators under the following conditions:

- 1) The antenna must be installed such that 20 cm is maintained between the antenna and users.
- 2) The transmitter module may not be co-located with any other transmitter or antenna.

IMPORTANT NOTICE:

FCC Radiation Exposure Statement:

This equipment complies with FCC radiation exposure limits set forth for an uncontrolled environment. This equipment should be installed and operated with minimum distance 20cm between the radiator & your body. To maintain compliance with FCC RF exposure compliance requirements, please avoid direct contact to the transmitting antenna during transmitting.

IC Notice:

Operation is subject to the following two conditions:

- 1) This device may not cause interference and
- 2) This device must accept any interference, including interference that may cause undesired operation of the device.

IMPORTANT NOTE:

IC Radiation Exposure Statement:

This equipment complies with IC radiation exposure limits set forth for an uncontrolled environment. End users must follow the specific operating instructions for satisfying RF exposure compliance. This equipment should be installed and operated with minimum distance 20cm between the radiator & your body.

This transmitter must not be co-located or operating in conjunction with any other antenna or transmitter.

Règlement d' Industry Canada

Les conditions de fonctionnement sont sujettes à deux conditions:

- (1) Ce périphérique ne doit pas causer d'interférence et.
- (2) Ce périphérique doit accepter toute interférence, y compris les interférences pouvant perturber le bon fonctionnement de ce périphérique.

Warning and Precautions of the lithium-ion battery

Warning:

Danger warning to prevent the possibility of the battery from leaking, heating, explosion, please observe the following precautions:

- Don't immerse the battery in water and seawater. Please put it in cool and dry environment if no using.
- Do not discard or leave the battery near a heat source as fire or heater.
- Being charged, using the battery charger specifically for that purpose.
- Don't reverse the positive and negative terminals.
- Don't connect the battery to an electrical outlet directly.
- Don't connect the positive and negative terminal directly with metal objects such as wire. Short terminals of battery is strictly prohibited, it may damage battery.
- Do not transport and store the battery together with metal objects such as necklaces, hairpins.
- Do not strike, throw or trample the battery.
- Do not directly solder the battery and pierce the battery with a nail or other sharp object.
- Do not use lithium ion battery and others different lithium polymer battery model in mixture.
- Prohibition of use of damaged cells.
- Don't bend or fold sealing edge. Don't open or deform folding edge. Don't fillet the end of the folding edge.
- Don't fall, hit, bend battery body.
- Battery pack designing and packing Prohibition injury batteries.
 - Never disassemble the cells.
 - Keep the battery away from babies.
 - Any components contacting these two edges, they must be insulated.

Caution:

- Risk of explosion if battery is replaced by an incorrect type. Dispose the battery according to local regulations.
- Never place batteries or devices on or in heating devices, such as microwave ovens, stoves, or radiators. Batteries may explode or leak flammable liquid when overheated or its performance will be degenerate and its service life will be decreased.
- Do not use it in a location where is electrostatic and magnetic greatly, otherwise, the safety devices may be damaged, causing hidden trouble of safety.
- If the battery leaks, and the electrolyte get into the eyes. Do not wipe eyes, instead, rinse the eyes with clean running water, and immediately seek medical attention. Otherwise, eyes injury can result.
- If the battery gives off an odor, generates heat, becomes discolored or deformed, or in any way appear abnormal during use, recharging or storage, immediately remove it from the device or battery charge and stop using it.
- Avoid charging batteries for more than a week, as overcharging may shorten battery life. Over time, unused batteries will discharge and must be recharged before use.
- Disconnect chargers from power sources when not in use.
- Use batteries only for their intended purposes.
- Store the battery at 0°C to 40°C.
- Highest specified charging temperature: 45±3°C (113±3°F); Lowest specified charging temperature: 0±2°C (32±2°F).
- Avoid exposing your device and batteries to very cold or very hot temperatures. Extreme temperatures can cause the deformation of the device and reduce the charging capacity and life of your device and batteries.
-

- Prevent batteries from contacting metal objects, as this can create a connection between the + and – terminals of your batteries and lead to temporary or permanent battery damage.
- In case the battery terminals are dirt, clean the terminals with a dry cloth before use. Otherwise power failure or charge failure may occur due to the poor connection with the instrument.
- Be aware discharged batteries may cause fire. Follow all local regulations when disposing of used batteries or devices.
- Never crush or puncture the battery. Avoid exposing the battery to high external pressure, which can lead to an internal short circuit and overheating.
- Exposure to extremely low air pressure may cause battery to explode or leak flammable liquid or gas.

1. Introduction

Congratulations on your purchase of the color sheet-fed image scanner. Avison is one of the leading companies to make high quality color image scanner.

Before you install and operate the new scanner, please take a few minutes to read through this manual. It provides proper instructions for you to unpack, install, operate and maintain the scanner.

1.1 Package Contents

The following figure indicates the package contents. Please check all the items against your checklist. If you do not receive all the items, please contact your authorized local dealer immediately.

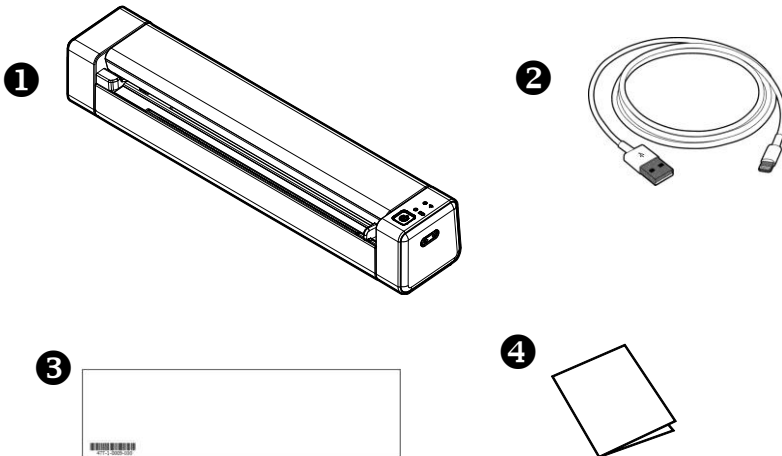

1. **Scanner Main Unit**
2. **USB Cable**
3. **Calibration Sheet**
4. **Quick Guide**

1.2 Top view

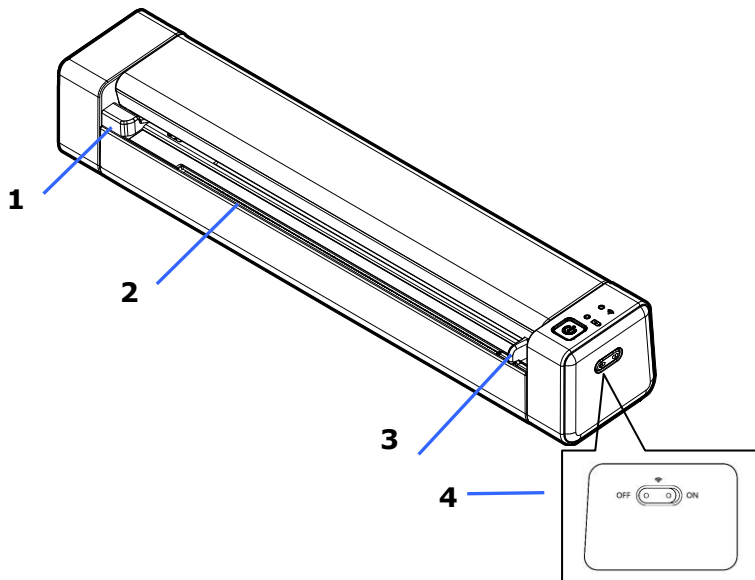

Item	Name	Description
1	Feeder slot left edge	Insert original into the feed slot, printed side UP and aligned with the left edge to begin scanning.
2	Feed slot	Feed your original to the slot.
3	Sliding paper guide	Slide the guide up to the right edge of the original before inserting original into the feed slot to ensure proper alignment when scanning.
4	Wi-Fi switch	Turn on and off the Wi-Fi connection.



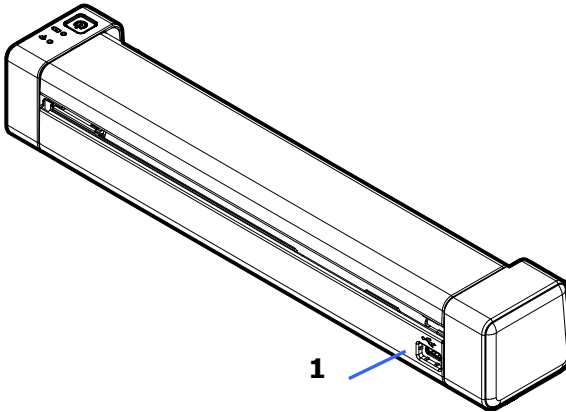





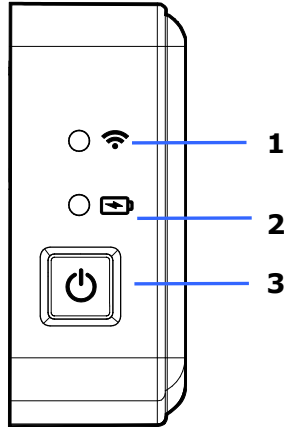

1.3 Side view













Item	Name	Description
1	USB Type-C	Used to plug the USB cable to connect to PC.

1.4 Control Panel



Item	Name	Description						
1	Wi-Fi LED 	The LED light is solidly lit in blue color to indicate successful Wi-Fi connection in AP (Access Point) mode.						
2	Battery LED 	<p>Used to indicate the power status of the battery.</p> <table border="1"> <tbody> <tr> <td> Blinking red  </td> <td>Low battery</td> </tr> <tr> <td> Red  </td> <td>Charging in progress.</td> </tr> <tr> <td> Green  </td> <td>Charging is finished.</td> </tr> </tbody> </table>	Blinking red 	Low battery	Red 	Charging in progress.	Green 	Charging is finished.
Blinking red 	Low battery							
Red 	Charging in progress.							
Green 	Charging is finished.							

<p>3</p>	<p>Power/Scan button</p> 	<ul style="list-style-type: none">● Press to turn on the power.● Long press for 3 seconds to turn off the power.● Press to start a scan via PaperAir software.	<table border="1"><tr><td data-bbox="491 432 678 632"><p>Blinking green</p></td><td data-bbox="678 432 996 632"><p>The scanner is in power-saving mode.</p><p>Press the Power button to wake from sleep.</p></td></tr></table>		<p>Blinking green</p> 	<p>The scanner is in power-saving mode.</p> <p>Press the Power button to wake from sleep.</p>
			<p>Blinking green</p> 	<p>The scanner is in power-saving mode.</p> <p>Press the Power button to wake from sleep.</p>		
			<table border="1"><tr><td data-bbox="491 632 678 772"><p>Green</p></td><td data-bbox="678 632 996 772"><p>The scanner is ready to scan.</p></td></tr></table>		<p>Green</p> 	<p>The scanner is ready to scan.</p>
			<p>Green</p> 	<p>The scanner is ready to scan.</p>		
<table border="1"><tr><td data-bbox="491 772 678 970"><p>Blinking red</p></td><td data-bbox="678 772 996 970"><p>An error has occurred.</p><p>Top cover is opened or the document is jammed.</p></td></tr></table>		<p>Blinking red</p> 	<p>An error has occurred.</p> <p>Top cover is opened or the document is jammed.</p>			
<p>Blinking red</p> 	<p>An error has occurred.</p> <p>Top cover is opened or the document is jammed.</p>					

2. Scanner Installation

2.1 Precautions

- Keep the scanner out of direct sunlight. Direct exposure to the sun or excessive heat may cause damage to the unit.
- Do not install the scanner in a humid or dusty place.
- Place the scanner securely on an even, flat surface. Tilted or uneven surfaces may cause mechanical or paper-feeding problems.
- Retain the scanner box and packing materials for shipping purposes.

2.2 Remove the Protective Tape

Remove the protective tapes on the scanner and inside the document feeder as illustrated in below.

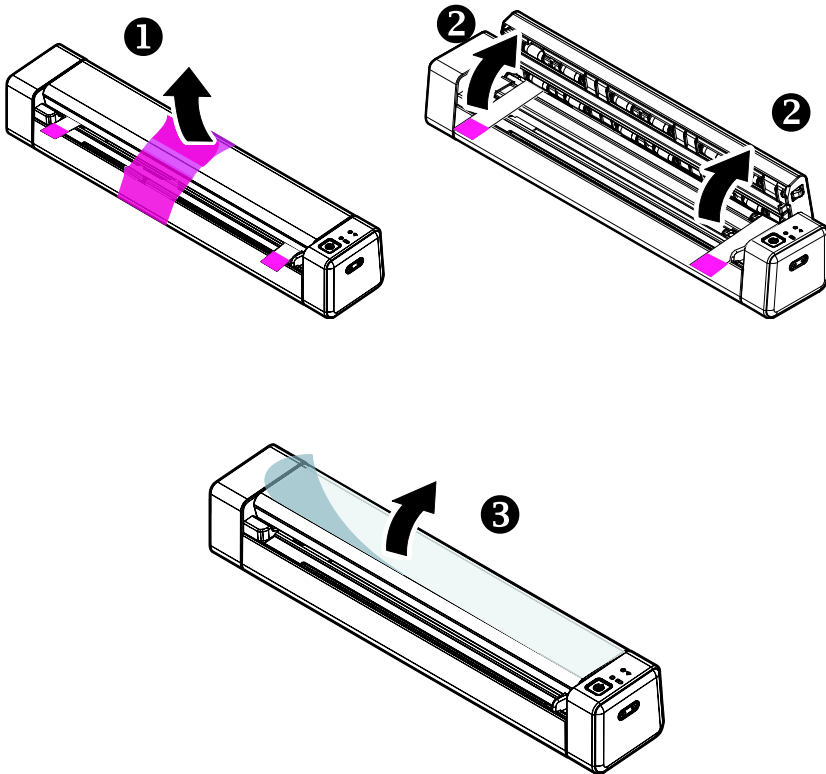

2.3 Charging the Battery

Please note the lithium battery has already been installed into the scanner. For first-time use, please charge the battery for at least 4 hours.

1. Turn off the scanner.
2. Connect the USB connector of the USB cable to the USB Type-C port of the scanner.
3. Connect the other USB connector of the USB cable to the USB port on your computer.

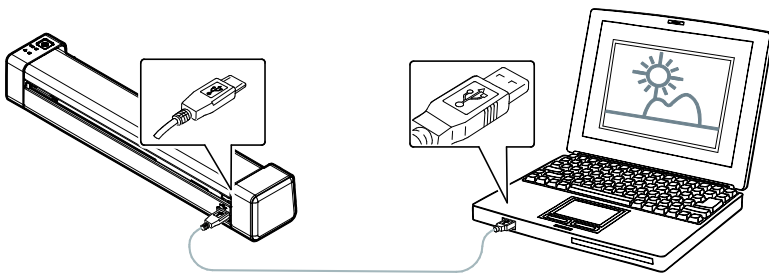

Important:

- Do not turn on the scanner power when charging the battery.
- While charging the battery, the red battery LED light will be solidly on. After the charging is completed, the battery LED light will turn solidly in green.
- When the battery is fully charged, an A4-sized page can be scanned for 300 times at 300 dpi!

2.4 Turning on the Scanner

Press the Power button to turn on the scanner. The Power LED will be first flashing and then solidly lit in green.

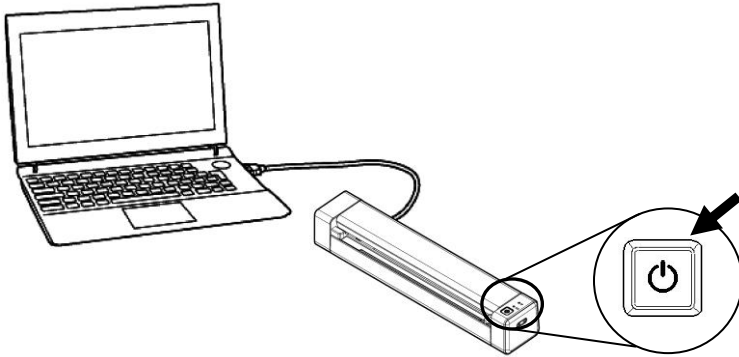

2.5 Connecting to the Computer

1. Connect the USB Type-C connector to the USB port of the scanner.
2. Connect the other USB connector to the USB port on your computer.

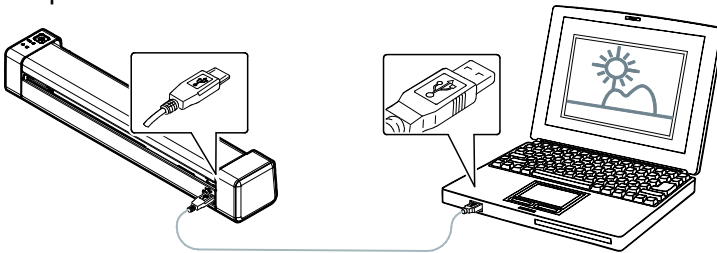

3. The computer should detect a new USB device and prompt a **"New Hardware Found"** message.
4. When the **Finish** dialog is prompted, click the **Finish** button.

2.6 Installing the Software

NOTE:

The scanner driver contains TWAIN, and WIA driver. After the installation of scanner driver is completed, this scanner allows you to scan via a TWAIN, or a WIA interface. Start your TWAIN-compliant image editing software application to select a TWAIN or WIA user interface. You may also launch Microsoft's Scanner and Camera Wizard to scan via a WIA user interface.

1. Download [**Avision Update**] at <http://www.avigon.com/install>.
2. Run [**Avision Update.exe**].
3. The End User License Agreement screen will be prompted. Read the agreement and then choose [**I Agree**].

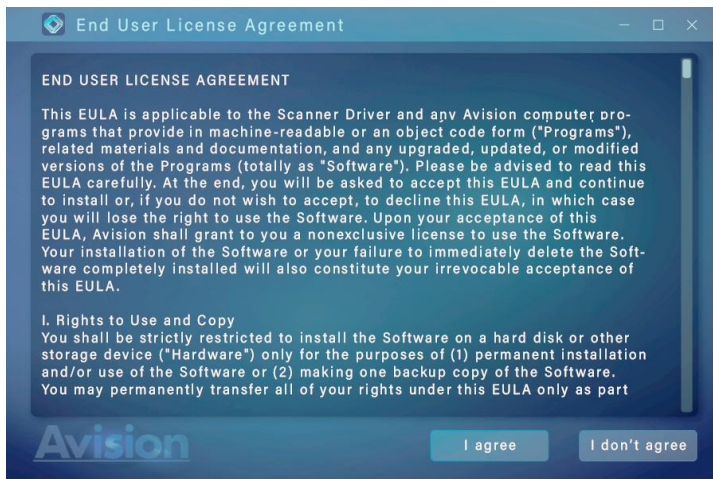

4. After your scanner has been recognized, click [**Next**] to continue.

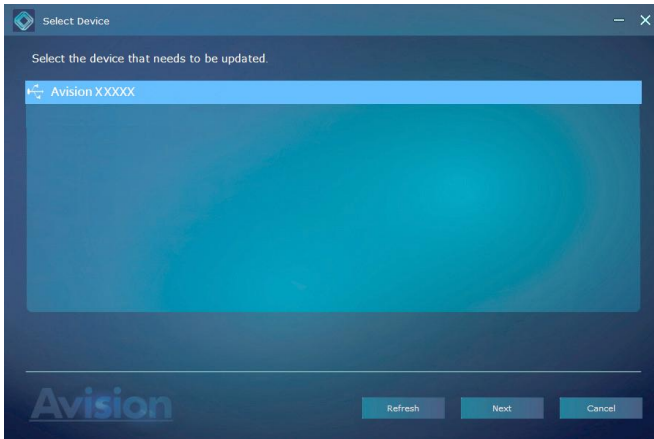

5. The available software applications will be prompted. Select the applications to install. Click [**Install**] and follow the on-screen instructions to complete the installation.



*The list of available software applications varies according to your product type.

Contents on the installation graphic:

- **Driver:** To communicate with your scanner, you need to install the scanner driver.
- **PaperAir:** To use the buttons on the scanner, you need to install PaperAir.
- **AVScan X/PaperPort:** To scan and organize your multi-page document(s), you can install the software application to manage them easily and effectively.

Alternatively,

You may also download driver and manual at www.avision.com/download.

3. Completing Your First Scan

3.1 Suitable and unsuitable original types

Suitable Original

The scanner is designed to obtain the best scanning results with the following types of originals:

- Photos and documents (3"x5", 4"x6", 5"x7", 8.5"x14") (76 x 127mm, 102 x 152 mm, 127 x 177 mm, 216 x 356 mm)
- Business cards [standard 3.5"x 2" (88 x 50 mm) or larger]
- Long page (8.5"x 36") (216 x 914 mm) for 300 dpi only

Unsuitable Original Type

Do not use the following types of originals for scanning, or the scanner may malfunction or cause the original to jam in the slot.

- Originals thicker than 0.8 mm
- Originals with either side shorter than 50 mm
- Originals with lots of black or dark colors
- Originals with dark colors surrounding the edges
- Printed media (newspapers, magazines, etc.)
- Soft and thin materials (thin paper, cloth, etc.)
- Originals that are curled or wrinkled
- Originals with staples or paper clips

3.2 Inserting Your Document

IMPORTANT:

- Insert only one page at a time, and insert the next one only when the previous one is done. Otherwise, the scanner may malfunction.
- The paper detector is quite sensitive. Please do not push your document into the feeding slot or the top of your image will be cut. Simply let go the photo (card) when it begins to feed into the slot.

1. Insert your document **FACE UP** to the feeder and align it to the left edge of the feeder.

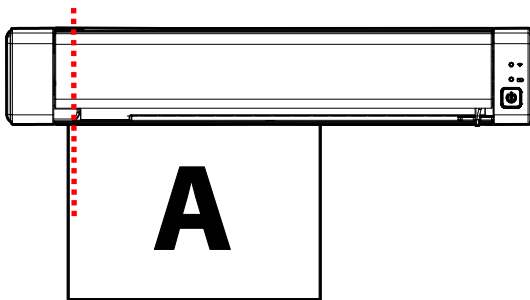

2. Gently push the original into the feed slot.
3. Slide the guide lever against the right side of the original.

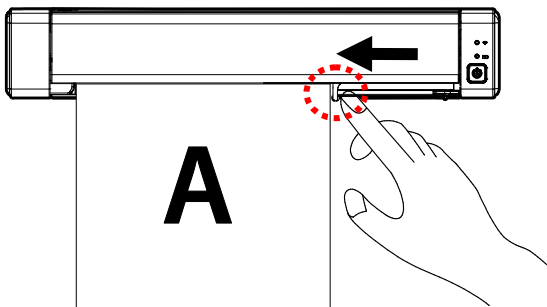

3.3 Verifying Your Scanner Installation

To verify if your scanner installation is correct, Avision provides you a useful test program called Avision Capture Tool. With this tool, you can perform simple scans and view the captured images. In addition, it helps you complete your scan at a rated speed.

The following procedure describes how to verify your scanner installation. If the installation is not correct, please review the preceding section to check if the cable connection and scanner driver have been successfully installed.

Before you begin, be sure the scanner is on.

1. Select Start>Programs>Avision XXXX Scanner>Avision Capture Tool (XXXX: your scanner model). The Select Scanner Model dialog box will be displayed.
2. Select your driver type and scanner model and click OK. The following Avision Capture Tool dialog box will be displayed.

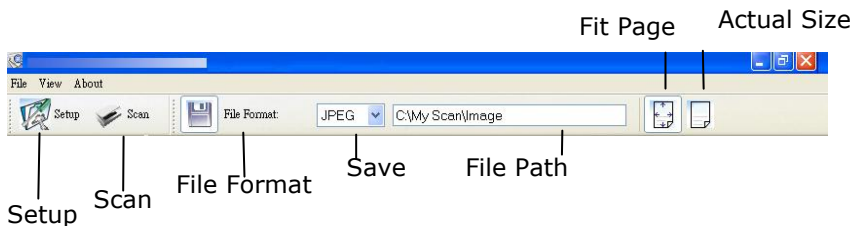

3. Choose your desired file format from the File Format drop down list box. (Default is BMP, other choice includes TIFF, MTIFF, PDF, MPDF, GIF, and JPEG.) The supported file formats vary depending on your scanner model.

4. Type your desired folder name and file name in the File Path box. (Default is C:\My Scan\Image.)

Note: If you do not wish to save the scanned image, deselect the Save button since default is Save Enable. In this case, the thumbnail view will be disabled. And therefore, after viewing all the scanned images, only the last one will remain on the screen.

5. Click the Setup button () or choose Setup from the File menu to prompt the Scanner Properties dialog box.

Image Selection Box

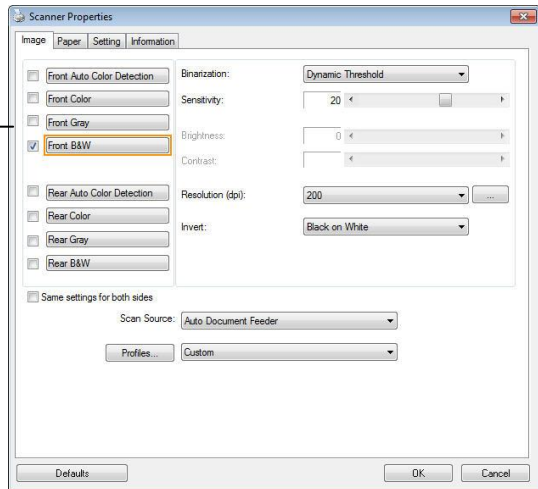

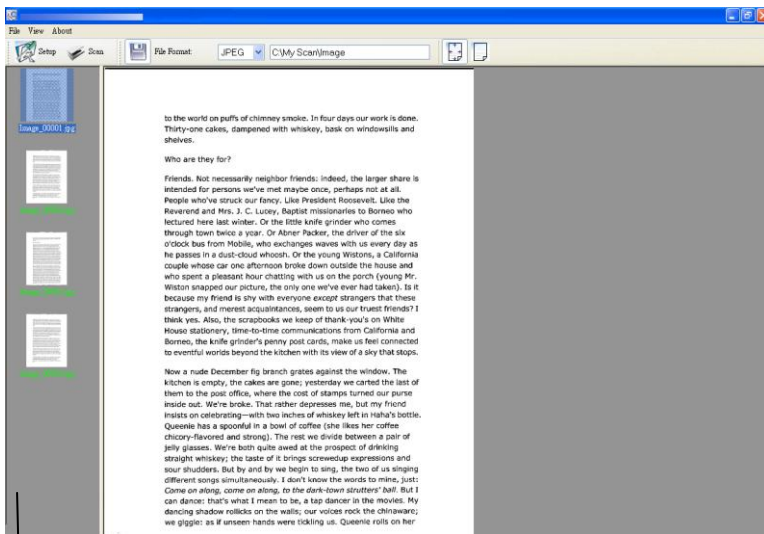

6. From the Image Selection Box, choose your desired image type for your scanned image. (Default is Front B&W) If you have a duplex scanner, choose Front and Rear to scan both sides of your document.
7. Click OK to quit the Scanner Properties dialog box. (To learn more details about the Scanner Properties dialog box, please see the subsequent chapter, *Using the Scanner Properties Dialog Box.*)

8. Place your document face down on the document glass or face up in the auto document feeder.
9. In the Scan Validation dialog box, click the Scan button () or choose Scan from the File menu.
10. The document will be scanned and displayed in the Scan Validation screen. After the scanned images have been displayed, your scanner installation verification is completed.



Thumbnail View

Fit Page View

11. You can view the scanned image in Fit Page () or Actual Size (100%) button () from the Viewing toolbars at the right side.
12. Click the Close box or Quit from the File menu to exit the Scan Validation Tool.

3.4 A Glance of the Scanner Properties Dialog Box

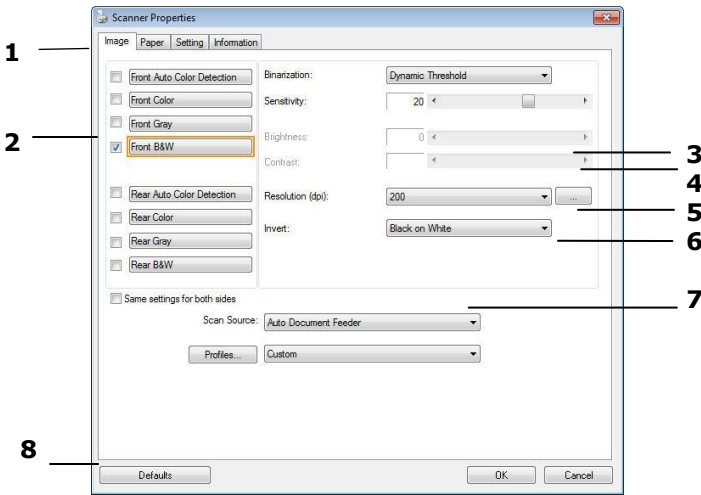

1. Tab Options	Choice: Image, Compression, Color Dropout, Paper, Multi-Feed Detection, Preview, Options, Settings, Information.
2. Image Selection Box	Choose your image type and the side of document you wish to scan. Options vary based on type of scanner.
3. Brightness	Adjust the brightness level from -100 to +100.
4. Contrast	Adjust the contrast level from -100 to +100.
5. Resolution	Determine the quality of the scanned image. The industry standard is 200 dpi.
6. Invert	Reverse the color of your scanned image.
7. Scan Source	Choice: Auto Document Feeder, Flatbed, Flatbed (Book), Automatic (varies due to different scanner model)
8. Defaults	Reset all values on the tabs to the factory default settings.

4. Using the Scanner Properties Dialog Box

The Scanner Properties dialog box allows you to configure the scanner's settings. It consists of several tabbed windows each of which will be described in this chapter.

NOTE:

In this chapter, all options are available based on a duplex (double-side) scanner. If you have purchased a simplex (single-side) scanner, all options are available for single sided only.

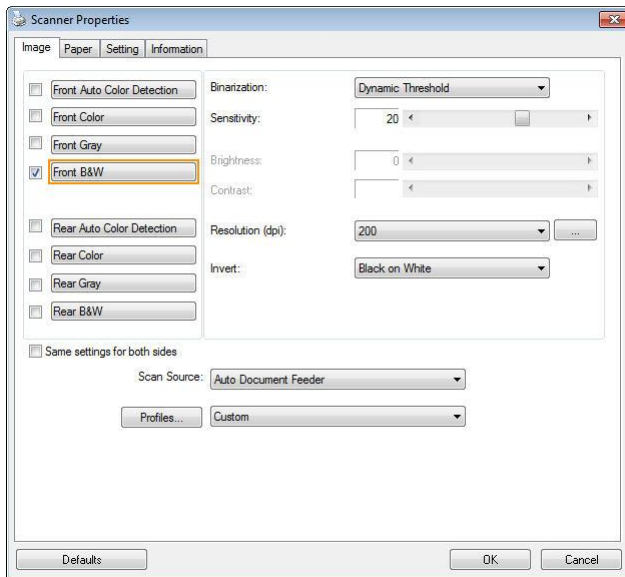

The Scanner Properties dialog box

4.1 Buttons on the Scanner Properties Dialog Box

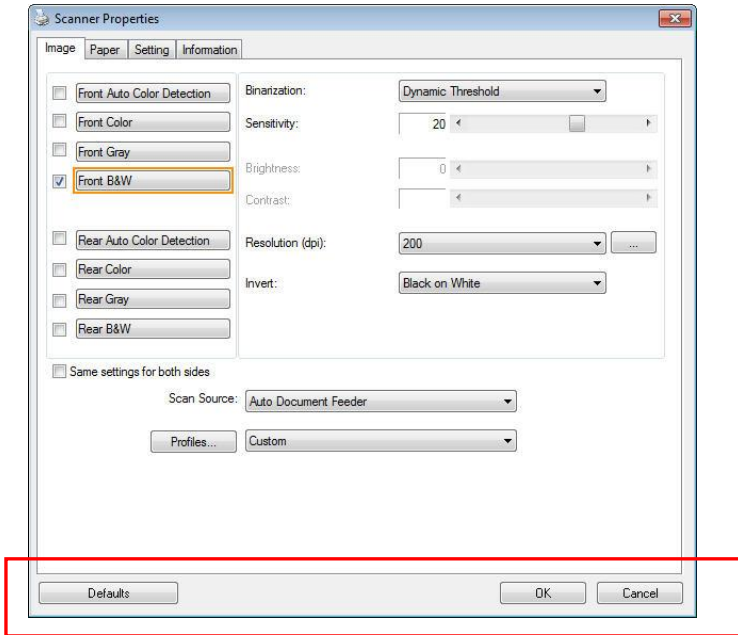

The buttons on the Scanner Properties dialog box

Buttons	Description
Defaults	Click the Defaults button, the factory default settings will be shown on each tab.
Cancel	Click the Cancel button to leave the Scanner Properties dialog box.

The following table shows the default settings :

Tab name	Default settings
Image	Image : Front B&W Binarization : Dynamic Threshold Resolution : 200 dpi Invert : Blank on White Scan Source : Auto Document Feeder Threshold : None Brightness : None Contrast : None
Compression	None
Color Dropout	None
Paper	Cropping : Automatic Deskew : Yes Orientation : Portrait OverScan : 0.00 Note: The availability of this option varies due to scanner model. Unit : Inch
Multi-Feed Detection	None
Preview	None
Options	Rotation Degrees : None Blank Page Removal : None Edge Fill : White , 0 mm Image Control Option : None
Setting	Enable Energy Saver : Enable, 15 minutes after last scan action Show Scanning Progress : Yes Show Warning Message : Yes Save Settings after Closing : Yes
Imprinter	Digital Imprinter

4.2 Showing or Hiding Tabs

The [**Scanner Properties**] dialog box is displayed in default with three basic tabs - Image, Paper, and Information. To show more tabs, click the [**Scanner Properties**] icon to access more scan settings.

To show more tabs,

1. Click the [**Scanner Properties**] icon () on the upper left corner, and choose [**Tab**] to show available tab names. The available tabs include Compression, Color Drop out, Preview, Rotation, Separation, Multi-Feed, Options, Settings, and Imprinter. (Note: the options vary based on scanner model.)
2. Choose the tab you want to display. The selected tab will be shown with a check mark and then displayed in the [**Scanner Properties**] dialog box.
3. To access the settings, click the selected tab on the top of the [**Scanner Properties**] dialog box. The page of the selected tab will be displayed.

To hide a tab window,

1. Click the [**Scanner Properties**] icon () on the upper left corner, and choose [**Tabs**] to show available tab names.
2. Choose the tab you want to hide. Then, the selected tab will be hid in the [**Scanner Properties**] dialog box.

Note: The [**Image**], [**Paper**], and [**Information**] tab can not be hid since they preprogrammed to be displayed by default.

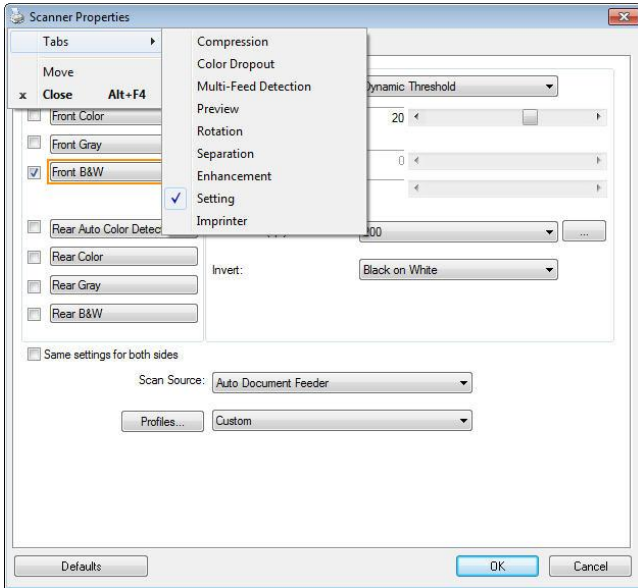

4.3 The Image Tab

The Image tab allows you to choose the front side and (or) the rear side of your document, the type of image, and to set several basic scan settings. Note that except for the resolution, you can set individual scan settings for the front side and the rear side. For example, all settings in the Image tab, Compression tab, Color Dropout tab can be set individually for the front and the rear side. However, the settings in the Paper tab, the Option tab, and the Setting tab have to be set the same for the front and rear side.

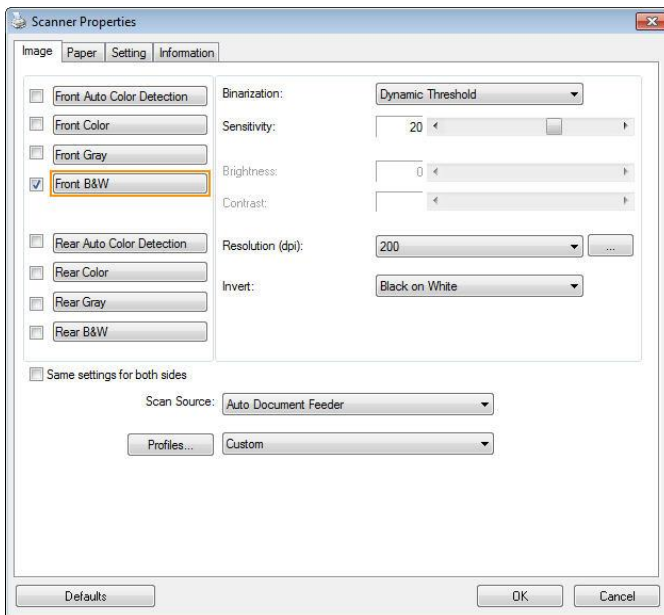



The Image tab dialog box

4.3.1 The Image Selection Box

<input type="checkbox"/> Front Auto Color Detection <input checked="" type="checkbox"/> Front Color <input type="checkbox"/> Front Gray <input type="checkbox"/> Front B&W <input type="checkbox"/> Rear Auto Color Detection <input checked="" type="checkbox"/> Rear Color <input type="checkbox"/> Rear Gray <input type="checkbox"/> Rear B&W	<p>The Image Selection box includes the image type and document side option. If you wish to scan both the front side and the rear side of your color document, you can check both Front Color and Rear Color at the same time. Note the options vary based on type of scanner.</p>
--	--

Example 1 : Scanning a two-sided color document, both sides in color

<input type="checkbox"/> Front Auto Color Detection <input checked="" type="checkbox"/> Front Color <input type="checkbox"/> Front Gray <input type="checkbox"/> Front B&W <input type="checkbox"/> Rear Auto Color Detection <input checked="" type="checkbox"/> Rear Color <input type="checkbox"/> Rear Gray <input type="checkbox"/> Rear B&W	<p>Front</p> 	<p>Rear</p> 
--	--	---

Side/Image Selection

Example 2 : Scanning a two-sided color document, one in B&W, the other in color





<div style="border: 1px solid black; padding: 5px;"> <input type="checkbox"/> Front Auto Color Detection <input checked="" type="checkbox"/> Front Color <input type="checkbox"/> Front Gray <input type="checkbox"/> Front B&W <input type="checkbox"/> Rear Auto Color Detection <input type="checkbox"/> Rear Color <input type="checkbox"/> Rear Gray <input checked="" type="checkbox"/> Rear B&W </div> <p>Side/Image Selection</p>	 <p>Front</p>	 <p>Rear</p>
---	---	--

Image Type	Description
Color	Choose Color if you wish to scan a color image for your original in color.
Gray	Choose Gray image if your original contains actual shades of gray.
B&W	Choose B&W if your original contains only text, pencil or ink sketch.

 <p>B&W</p>	 <p>Gray</p>	 <p>Color</p>
--	---	--

Front/Rear Auto Color Detection:

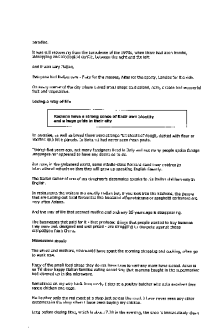
Click to automatically detect and scan the front or the rear page of your color document in color image mode. If your document is in colors, the scanner will automatically scan the document into a color image. If your document is non-color, you can choose the output to be either B&W or Gray from the Non-Color Selection option. This option is useful when you have a mixture of color and non-color document.

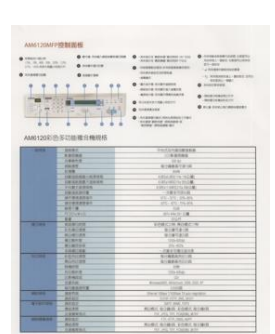
Note: If you choose Front Rear Auto Color Detection, you can not specify the image mode of your rear page and vice versa.

Modes of Auto Color Detection:

If [**Front/Rear Auto Color Detection**] is selected, its modes will be displayed. **Choice includes Normal, Ignore Paper Color.** For paper with background color such as invoices, choosing [**Ignore Paper Color**] will automatically remove the background color and enhance the detection accuracy.

<p>Normal</p>	<p>Ignore single background color</p>

Sensitivity of Auto Color Detection

If your documents contain primarily B&W text and small amount of light or pale colors and you do not wish them to be recognized as color image to save the file size, you can increase the sensitivity value by moving the bar to the right to let these images to be detected as B&W. The value ranges from 1 to 100. The default is 37.

Standard	IEEE 802.11 b/g/n standards compliant	
Wireless LAN	11n Mode	
Frequency Range	2.400 ~ 2.4835GHz (subject to local regulations)	
Number of Selectable Channels	802.11n: 20MHz/40MHz	
	802.11b/g:	USA, Canada (FCC):11 channels (2.412GHz~2.462GHz) Europe (CE): 13 channels (2.412GHz~2.472GHz) Japan (TELEC): 14 channels (2.412GHz~2.4835GHz)
Data Rate	802.11n: up to 150Mbps 802.11b: 1, 2, 5.5, 11Mbps 802.11g: 6, 9, 12, 18, 24, 36, 48, 54Mbps	
Transmit Power(EIRP)	11n HT40 MCS7 : +13 dBm 11g OFDM: +15 dBm 11b CCK: +18 dBm	
Security	WEP 64/128, TKIP, WPA, WPA2 mixed,802.1x and 802.11i	

Original

Standard	IEEE 802.11 b/g/n standards compliant	
Wireless LAN	11n Mode	
Frequency Range	2.400 ~ 2.4835GHz (subject to local regulations)	
Number of Selectable Channels	802.11n: 20MHz/40MHz	
	802.11b/g:	USA, Canada (FCC):11 channels (2.412GHz~2.462GHz) Europe (CE): 13 channels (2.412GHz~2.472GHz) Japan (TELEC): 14 channels (2.412GHz~2.4835GHz)
Data Rate	802.11n: up to 150Mbps 802.11b: 1, 2, 5.5, 11Mbps 802.11g: 6, 9, 12, 18, 24, 36, 48, 54Mbps	
Transmit Power(EIRP)	11n HT40 MCS7 : +13 dBm 11g OFDM: +15 dBm 11b CCK: +18 dBm	
Security	WEP 64/128, TKIP, WPA, WPA2 mixed,802.1x and 802.11i	

Standard	IEEE 802.11 b/g/n standards compliant	
Wireless LAN	11n Mode	
Frequency Range	2.400 ~ 2.4835GHz (subject to local regulations)	
Number of Selectable Channels	802.11n: 20MHz/40MHz	
	802.11b/g:	USA, Canada (FCC):11 channels (2.412GHz~2.462GHz) Europe (CE): 13 channels (2.412GHz~2.472GHz) Japan (TELEC): 14 channels (2.412GHz~2.4835GHz)
Data Rate	802.11n: up to 150Mbps 802.11b: 1, 2, 5.5, 11Mbps 802.11g: 6, 9, 12, 18, 24, 36, 48, 54Mbps	
Transmit Power(EIRP)	11n HT40 MCS7 : +13 dBm 11g OFDM: +15 dBm 11b CCK: +18 dBm	
Security	WEP 64/128, TKIP, WPA, WPA2 mixed,802.1x and 802.11i	

Sensitivity: 1
(The image is recognized as a color one)

Sensitivity: 100
(The image is recognized as a black and white one)

Same settings on both sides:

Click to apply same scan settings for both sides of your documents. After checking this option, any settings you have changed will automatically applied to both the front side and the rear side. For example, if you choose your ideal resolution to be 300 dpi, this will be applied both to the front side and rear side of your document.

4.3.2 Other Image Options

Binarization This is the process of converting a grayscale or color image to a bi-tonal image. There are several different methods of performing this conversion.

Options: Dynamic Threshold, Dynamic Threshold (AD), Fixed Processing, Halftone 1~5, Error Diffusion.

Dynamic Threshold: Selecting **Dynamic Threshold** allows the scanner to dynamically evaluate each document to determine the optimal threshold value to produce the highest quality image. This is used to scan mixed document containing faint text, shaded background, or color background with a single setting. If Dynamic Threshold is selected, Threshold, Brightness, and Contrast are not available.

Dynamic Threshold (AD): Selecting **Dynamic Threshold (AD)** to perform the enhanced mode of the Dynamic Threshold feature. However, using this mode may slow down your scanning speed.

Sensitivity of Dynamic Threshold Occasionally your scanned image may contain small dots or speckles. To remove these spots, increase the sensitivity value by moving the bar to the right. The value ranges from 1 to 30. The default is 20.

Fixed Processing: Used for black-and-white and other high contrast documents. A single level is set to determine the black-and-white transition. The threshold is programmable over the entire density range. **Fixed Processing** sets Contrast to 0. If **Fixed Processing** is selected, Contrast is not available.

Halftone: In addition to the black and white display, Halftone can present a somehow gray shade of image by using different size of dots. Halftone image looks like the picture we have seen in the newspaper. **Options include Halftone 1, Halftone 2, Halftone 3, Halftone 4, Halftone 5.**

Error Diffusion: Error Diffusion is a type of Halftone. Error Diffusion gives good image texture and makes text in images more readable than Halftone.



Halftone Image



H
F. Michelangi
Architecture
this huge volt
sculpture, pai
photographs,
ceiling with a
illus. (120 in c
10 3/4" x 14"

G. NEW Botti
Renaissance
unprecedente
first lifesize m
enormous ne

Error Diffusion Image

<p>Dynamic Threshold</p>	<p>Dynamic Threshold (AD)</p>

Threshold

Used to convert a grayscale image to a bi-tonal image. The value ranges from 0 to 255. A low threshold value produces a lighter image, and can be used to subdue backgrounds and subtle, unneeded information. A high threshold value produces a darker image, and can be used to help pick up faint images.

Adjust the threshold setting by dragging the Threshold sliding bar to the left or right to achieve the desired threshold setting.

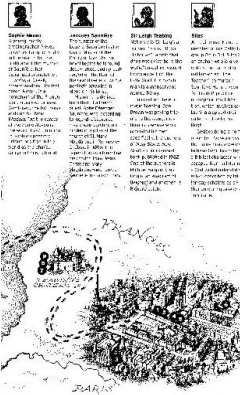

**200 dpi,
Threshold:50,
Brightness: 0**

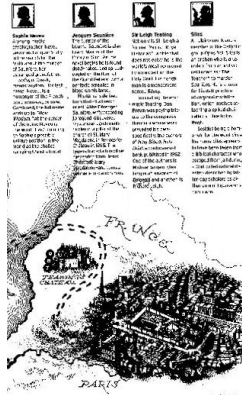

**200 dpi,
Threshold:100,
Brightness: 0**

Gray

Document Type: Choice: Normal, Photo, Document

Three options of document type are provided when you choose Gray as the image type for your scanned document.

Choice: Normal, Photo, Document.

- **Document:** Choose Document if your original contains pure text or a mixture of text and graphic since it is an optimal setting for regular business document. When using Document, only Threshold can be adjusted.
- **Photo:** Choose Photo if your original contains photo to reproduce your photo in vivid grayscale image. When using Photo, no Threshold and Contrast can be adjusted.
- **Normal:** When using **Normal**, Threshold, Brightness, and Contrast can be adjusted.

Threshold: The value ranges from 0 to 255. The default is 230. A low threshold value produces a lighter image, and can be used to subdue backgrounds and subtle, unneeded information. A high threshold value produces a darker image, and can be used to help pick up faint images. Adjust the threshold setting by dragging the **Threshold** sliding bar to the left or right to achieve the desired threshold setting.

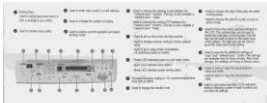

Parameter	Default value
Resolution	300 x 300 dpi
Color mode	Color
Image size	A4
Page range	1
File format	PDF
File name	Scanner0001.pdf
File path	C:\Users\user\Desktop
File size	100 MB
File type	PDF
File extension	.pdf
File encoding	UTF-8
File permissions	Full control
File security	None
File compression	Yes
File password	None
File encryption	None
File signature	None
File metadata	None
File creation date	None
File modification date	None
File creation time	None
File modification time	None
File creation date and time	None
File modification date and time	None
File creation date and time (UTC)	None
File modification date and time (UTC)	None
File creation date and time (local)	None
File modification date and time (local)	None
File creation date and time (UTC) (local)	None
File modification date and time (UTC) (local)	None
File creation date and time (local) (UTC)	None
File modification date and time (local) (UTC)	None
File creation date and time (local) (UTC) (local)	None
File modification date and time (local) (UTC) (local)	None
File creation date and time (local) (UTC) (local) (UTC)	None
File modification date and time (local) (UTC) (local) (UTC)	None
File creation date and time (local) (UTC) (local) (UTC) (local)	None
File modification date and time (local) (UTC) (local) (UTC) (local)	None
File creation date and time (local) (UTC) (local) (UTC) (local) (UTC)	None
File modification date and time (local) (UTC) (local) (UTC) (local) (UTC)	None

Normal

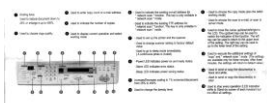

Parameter	Default value
Resolution	300 x 300 dpi
Color mode	Color
Image size	A4
Page range	1
File format	PDF
File name	Scanner0001.pdf
File path	C:\Users\user\Desktop
File size	100 MB
File type	PDF
File extension	.pdf
File encoding	UTF-8
File permissions	Full control
File security	None
File compression	Yes
File password	None
File encryption	None
File signature	None
File metadata	None
File creation date	None
File modification date	None
File creation time	None
File modification time	None
File creation date and time	None
File modification date and time	None
File creation date and time (UTC)	None
File modification date and time (UTC)	None
File creation date and time (local)	None
File modification date and time (local)	None
File creation date and time (UTC) (local)	None
File modification date and time (UTC) (local)	None
File creation date and time (local) (UTC)	None
File modification date and time (local) (UTC)	None
File creation date and time (local) (UTC) (local)	None
File modification date and time (local) (UTC) (local)	None
File creation date and time (local) (UTC) (local) (UTC)	None
File modification date and time (local) (UTC) (local) (UTC)	None
File creation date and time (local) (UTC) (local) (UTC) (local)	None
File modification date and time (local) (UTC) (local) (UTC) (local)	None
File creation date and time (local) (UTC) (local) (UTC) (local) (UTC)	None
File modification date and time (local) (UTC) (local) (UTC) (local) (UTC)	None

Photo



Parameter	Default value
Resolution	300 x 300 dpi
Color mode	Color
Image size	A4
Page range	1
File format	PDF
File name	Scanner0001.pdf
File path	C:\Users\user\Desktop
File size	100 MB
File type	PDF
File extension	.pdf
File encoding	UTF-8
File permissions	Full control
File security	None
File compression	Yes
File password	None
File encryption	None
File signature	None
File metadata	None
File creation date	None
File modification date	None
File creation time	None
File modification time	None
File creation date and time	None
File modification date and time	None
File creation date and time (UTC)	None
File modification date and time (UTC)	None
File creation date and time (local)	None
File modification date and time (local)	None
File creation date and time (UTC) (local)	None
File modification date and time (UTC) (local)	None
File creation date and time (local) (UTC)	None
File modification date and time (local) (UTC)	None
File creation date and time (local) (UTC) (local)	None
File modification date and time (local) (UTC) (local)	None
File creation date and time (local) (UTC) (local) (UTC)	None
File modification date and time (local) (UTC) (local) (UTC)	None
File creation date and time (local) (UTC) (local) (UTC) (local)	None
File modification date and time (local) (UTC) (local) (UTC) (local)	None
File creation date and time (local) (UTC) (local) (UTC) (local) (UTC)	None
File modification date and time (local) (UTC) (local) (UTC) (local) (UTC)	None

Document
(Threshold: 230)



Normal



Photo



Document
(Threshold: 230)

Brightness Adjusts the lightness or darkness of an image. The higher the value, the brighter the image. Drag the slider to the right or left to increase or decrease the brightness. The range is from -100 to +100.

Contrast Adjusts the range between the darkest and the lightest shades in the image. The higher the contrast, the bigger the different grayscale. Drag the slider to the right or left to increase or decrease the contrast. The range is from -100 to +100.

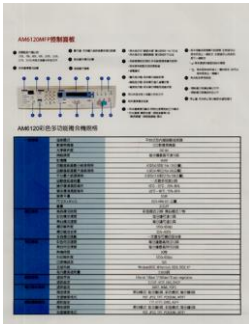

Brightness: -50



**Brightness: 0
(Normal)**

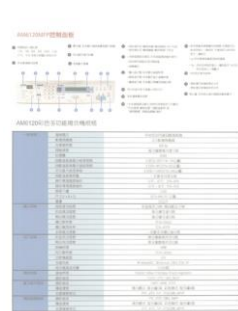

Brightness: +50

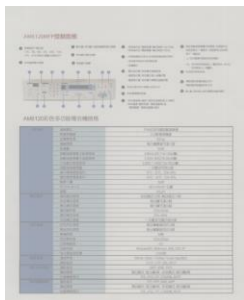

Contrast: -50

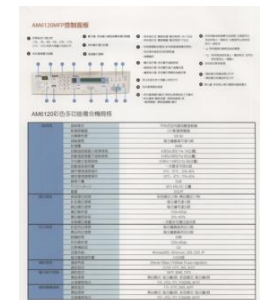

**Contrast: 0
(Normal)**

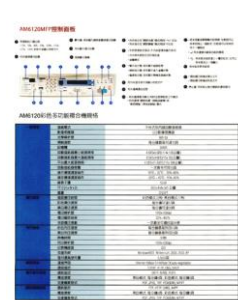

Contrast: +50

Resolution

A good control of the resolution results a good detail of an image that scans. The resolution is measured by dots per inch (dpi). Normally, the greater the dpi number, the higher the resolution and the image file size. Be aware that greater resolution takes more time to scan, and more disk space for the scanning image. For your information, an A4 size color image scanned at 300 dpi at True Color mode consumes approximately 25 MB of disk space. A higher resolution (usually means over 600 dpi) is only recommended when you need to scan a small area at True Color mode.

Choose a resolution value from the drop down list. The default value is 200 dpi. Available resolutions are 75, 100, 150, 200, 300, 400 and 600. Or you may choose your desired value by clicking the box in the right side of the drop down list and press the arrow key to select your desired value and then click the Add button to include it in the drop down list. **Note:** The resolution is up to 300 dpi if an imprinter or a MICR reader is installed or connected to the scanner.



Resolution: 75 dpi



Resolution: 150 dpi

Invert Reverses the brightness and the colors in the image. The default setting is Black on a White background. Reverse mode is White on a Black background. For color images, each pixel will be changed into its complementary color at the command of Invert.

"I am not worthy to have you enter my

that is God, I beg all my brothers - those who work manually, clerics and lay brothers
ards being humble in all things; not to glorify
to become Interlorly proud because of good w
sometimes says or does in them or through tl
ord: "Do not rejoice... in the fact that the de
: 10:20) Let us be firmly convinced of the fact

Black on White

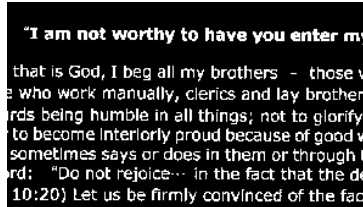

White on Black

**Scan
Source****Choice:**

- **Auto Document Feeder:** Used to scan multiple pages.
- **Flatbed:** Used to scan a single page. For example, pages from newspaper clipping, paper with wrinkles or curls.
- **Flatbed (book):** Used to scan several inside pages from book.
- **Automatic:** Allow the scanner automatically set its scan source. If **Automatic** is selected and there is document in both the auto document feeder (ADF) and the flatbed, then the scan source will be automatically set to ADF. If **Automatic** is selected and there is document only in flatbed, then the scan source will be set to flatbed.
- **Merge Two Sides into One Image:**
If you have a sheet-fed duplex scanner with front input tray, you can scan an A3 size document with an innovative method. Thus, fold your A3 size document into A4, and then load the paper in the front tray. Choose Merge Two Sides from the Scan Source option and then the scanner is able to scan both sides of your document and merge two A4 images into one A3 image.

When you select Merge Two Sides into One Image, the Cropping or Multi-feed function will be disabled.

Note: This feature must be used with a carrier sheet. Regarding how to load a document with a Carrier Sheet, refer to Section 4.6.2, Other Paper Selection.

Note the options vary based on type of scanner.

NOTE:

If you have purchased a duplex sheet-fed scanner, choose [Merge Two Sides] on the [Scan Source], then the scanner is able to scan both sides of your document and merge them into a single image.

If "Merge Two Sides into One Image" is selected, its choice will be available including "Merge Horizontally", "Merge Vertically", "Merge Vertically (Back Side Flip)". If the reverse side of your document is upside down, choose "Merge Vertically (Back Side Flip)" and the back side will be automatically rotated 180 degrees and merged.

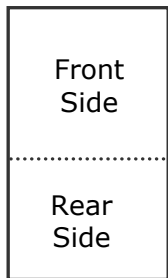

Merge Vertically

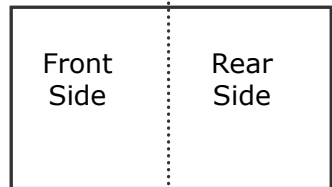

Merge Horizontally

Note the options vary based on type of scanner.

Color Matching

The purpose of Color Matching is getting the accurate color. This option uses the default parameters (ICC profile) to adjust the colors of the image.

Choice: None, Document, Photo

- **None:** Choose "None" to disable this option.
- **Document:** Choose "Document" if your original contains pure text or a mixture of text and graphic since it is an optimal setting for regular business document.
- **Photo:** Choose "Photo" if your original contains photo to reproduce your photo in vivid color image.



Normal



After Color Matching

4.3.3 Scanning color images

The following options are available for scanning color images.

- Brightness
- Contrast
- Resolution
- Invert

4.3.4 Scanning grayscale images

The following options are available for scanning gray images.

- Brightness
- Contrast
- Resolution
- Invert

4.3.5 Scanning B&W images

The following options are available for scanning B&W images.

- Binarization (Dynamic Threshold)
- Resolution
- Invert

Or

- Binarization (Fix Processing)
- Threshold
- Brightness
- Resolution
- Invert

4.3.6 Editing Profiles

The Scanner Properties dialog box allows you to change and save your frequently used scan settings into a profile. You can edit these profiles by renaming or deleting them.

To add a new profile,

1. Customize your settings. (For example, change your resolution, image type, cropping method, scan size, or other scan settings.)
2. Click the Image tab and then choose "Profiles" to prompt the "Edit Your Profile" dialog box.

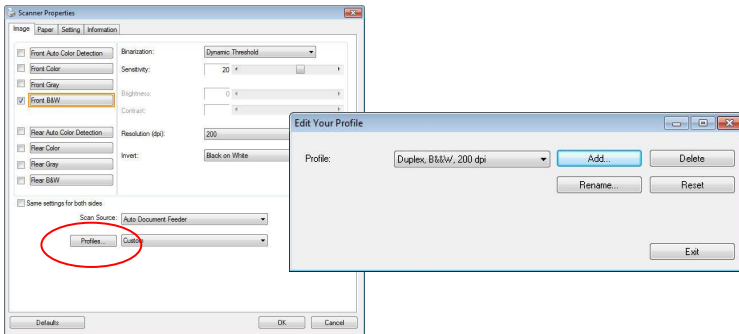

3. Click "Add" to enter the name of the profile and then choose "Save".



4. The new profile will be saved and shown in the "Profiles" dropdown list box.

To load a profile,

1. From the Image tab dialog box, choose your favorable profile from the "Profiles" dropdown list box.

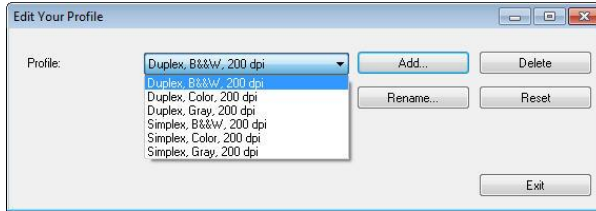

2. Your favorable profile will be immediately loaded and displayed on Scanner Properties dialog box.

To delete a profile,

1. From the Image tab dialog box, click "Profiles" to prompt the Edit Your Profile dialog box.

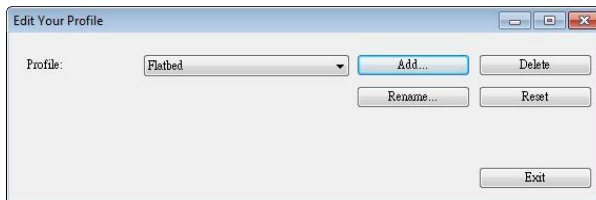

2. Choose the profile you want to delete from the dropdown list box.
3. Click "Delete". A Confirm message "Are you sure you want to delete this profile?" is prompted.
4. Choose "Yes" to delete or "Cancel" to quit.

To rename a profile,

1. From the Image tab dialog box, click "Profiles" to prompt the Edit Your Profile dialog box.

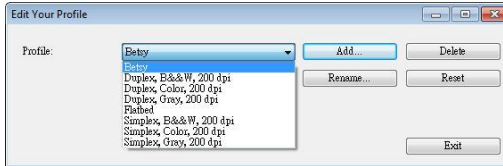

2. Choose the profile you want to rename from the dropdown list box and then click the Rename button.
3. Enter new name for the profile.



4. Choose "Save" to save the new profile or "Cancel" to quit.

NOTE:

- The preset default profiles include Flatbed, Simplex-B&W, 200 dpi, Simplex-Gray, 200 dpi, Simplex-Color, 200 dpi, Duplex-B&W, 200 dpi, Duplex-Gray, 200 dpi, Duplex-Color, 200 dpi. If you have a simplex or a sheetfed scanner, the duplex or the flatbed option will not be available.
- If any setting for a current profile has been changed, a [*] sign will be marked before the name of current profile, for example, [* **Duplex, Color, 200 dpi**]. If desire, click the [OK] or [Scan] button and a dialog box will be prompted to let you save the new profile.

4.4 The Compression Tab

The Compression tab allows you to compress your scanned image and choose the level of compression. Bi-tonal images are normally compressed using CCITT standard called Group 4 (G4). Color and grayscale images are often compressed using JPEG technology. Move the **JPEG Quality** slider to the right or left to increase or decrease the level of compression. Note the greater the compression level, the lower image quality. Default is 50%.

Note that the compression depends on your image editing application. If your image editing application does not support the type of compression format, then either a warning message will appear or the image quality of the compressed file will not be acceptable.

JPEG (Joint Photographic Editor Group). This group developed and lent their name to a file compression standard for color and grayscale images that is widely used by scanners, and software applications. On Microsoft Windows-based systems, a file with the extension .jpg has normally been compressed using this standard.

For scanning color or gray images, the following compressions are available:

- None
- JPEG

For scanning B&W images, the following compressions are available:

- None
- G4

Compression:

To complete your scan at a rated speed, the scanned image is compressed by default during transmission. However, if you wish to obtain the highest image quality, you can choose to uncompress the image data before it is outputted.

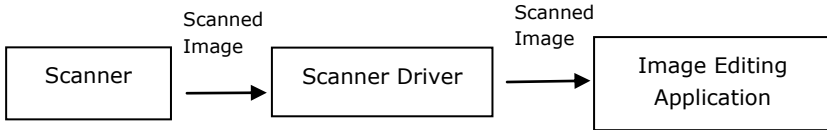

To Application:

Choose if you wish to compress the image data and transfer it from the TWAIN driver to the application. Note Bi-tonal images are normally compressed using CCITT standard called Group 4 (G4). Color and grayscale images are often compressed using JPEG technology. Move the [**Image Quality**] slider to the right or left to increase or decrease your image quality. Note the greater the image quality, the lower the compression level. Default is 50%.

Note that the compression depends on your image editing application. If your image editing application does not support the type of compression format, then the image of the compressed file will look abnormal.

From Scanner: (Note: The availability of this feature varies due to scanner model.)

Choose if you wish to compress the scanned image and transfer it from the scanner to the TWAIN driver.
 Choice: Uncompressed, *Best Image Quality (Low Compression Level), Better Image Quality (Normal Compression Level), Normal Image Quality (High Compression Level). (*: Factory Default)

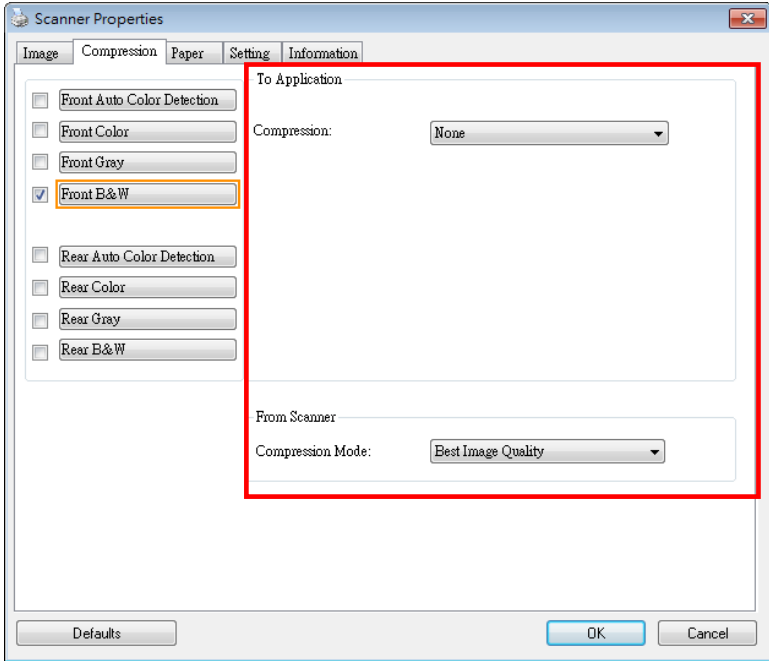

The Compression tab dialog box

4.5 The Color Dropout Tab

4.5.1 Color Dropout Selection

The [**Color Dropout**] tab allows you to select either green, red, blue, or a color of your choice to remove the details of the selected color from a scanned image. This feature is used to sharpen your text when using OCR (Optical Character Recognition) software. Note this feature applies only to the gray or black and white image.

Choice: None, Auto, Remove Red, Remove Green, Remove Blue, Custom

- **None:** Does not remove any color.
- **Auto:** Automatically outputs the image with the details of the primary color removed.
- **Remove Red/Remove Green/Remove Blue:** Outputs the image with the details of the specified color removed.
- **Custom:** Specify the color you wish to remove by entering its RGB (Red, Green, and Blue) value respectively.

Advanced Options:

- **Quality Mode:** Range: 0~20. Default: 10
When [Quality Mode] is selected, you can determine the color to be dropped out using the [Filter Threshold] slider. A lower value will drop more of the selected color out, while a higher value will leave more of the selected color in.
- **Normal Mode:** Use an optimized setting to determine the color.

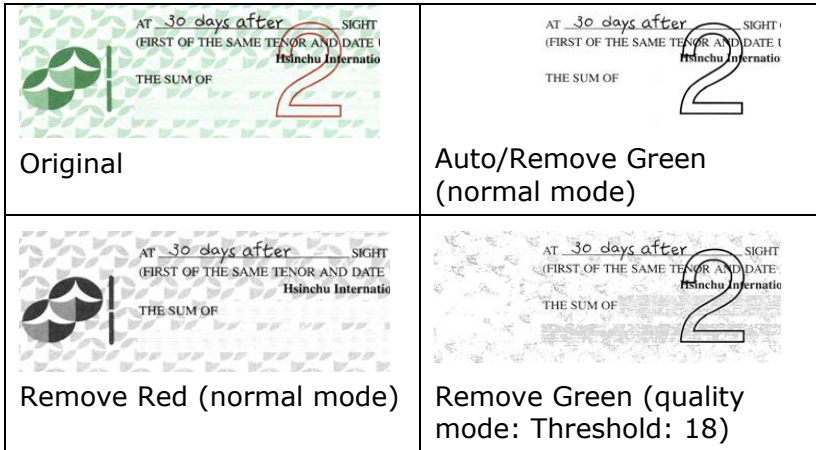

Preview the color dropout result:

To preview the color dropout result, please follow these steps:

1. Click the [**Scanner Properties**] icon () on the upper left corner, and choose [**Tab**] to show available tab names.
2. Choose [**Preview**] to show the Preview tab.
3. Click the [**Preview**] tab to show the Preview page.
4. Load your document to the scanner and click the [**Preview**] button to get a preview image.
5. On the [Image] tab, click [Gray] or [Black and White] image mode and then choose [Custom] on the [Color Dropout] tab. A [Preview window] button will be displayed.
6. Click the [**Preview window**] button to prompt the [**Preview**] window with the previewed image.

7. Move your cursor over the preview image. Your mouse cursor now becomes an Eyedropper.
8. Click to select a color which you wish to remove.
9. Click and hold your mouse button to view the result after removing the specified color. If the result is satisfactory, click **[OK]** to close the Preview window.



The Preview Window

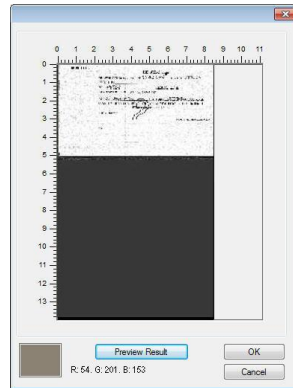

The Color dropout result

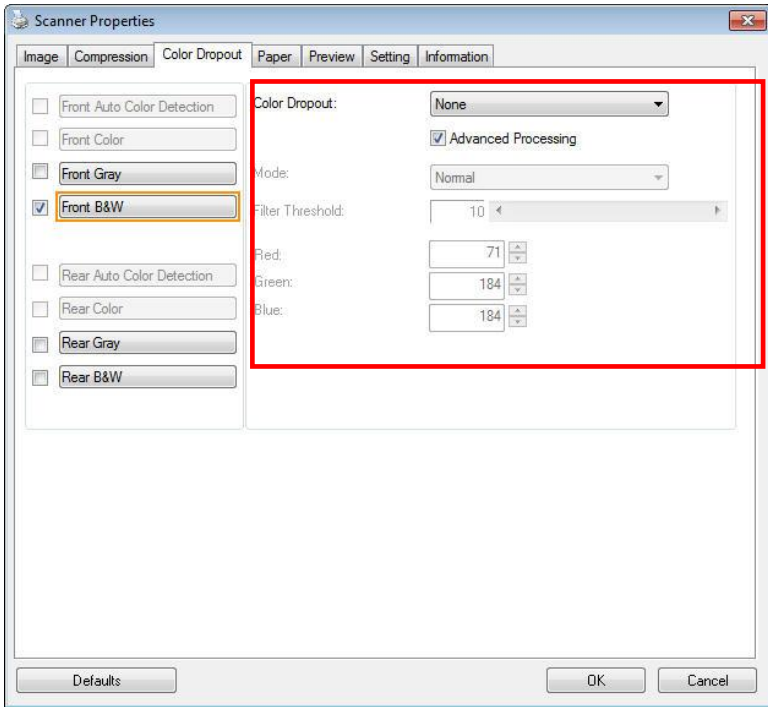

The Color Dropout dialog box

To select a color on the Color palette,

1. Click the Color Dropout tab from the Scanner Properties dialog box.

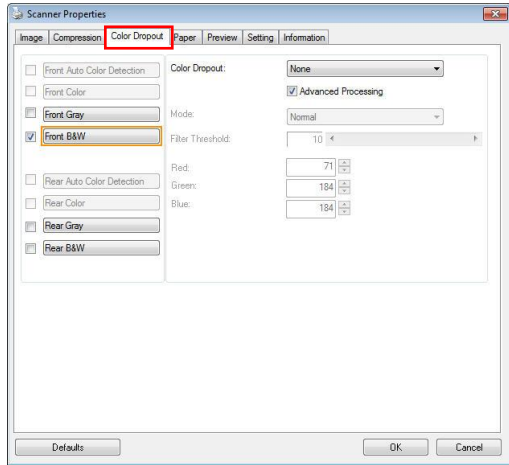

2. Choose Gray or B&W from the Image Selection box and click "Custom" from the Color Dropout drop-down menu. The Color palette appears.

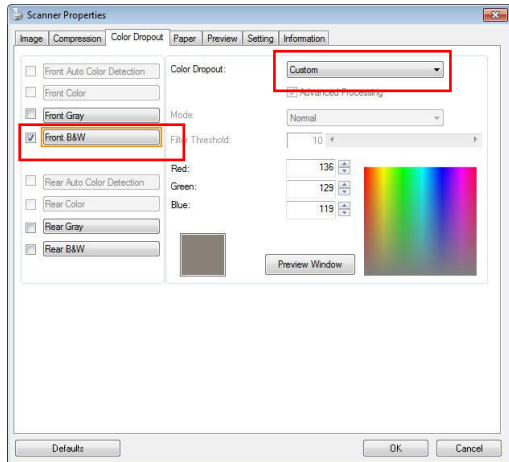

3. Move your cursor over the palette. The cursor becomes a cross sign.

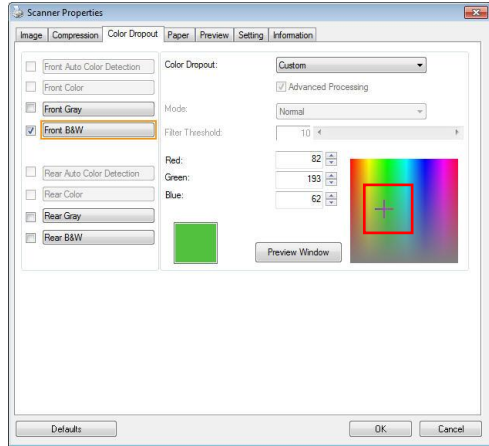

4. Click to choose a color. The RGB values are changed simultaneously.

4.6 The Paper Tab

The Paper tab allows you to define values relating to image output (i.e., Auto Crop or not, Scan Area, OverScan, Multi-Feed Detection).

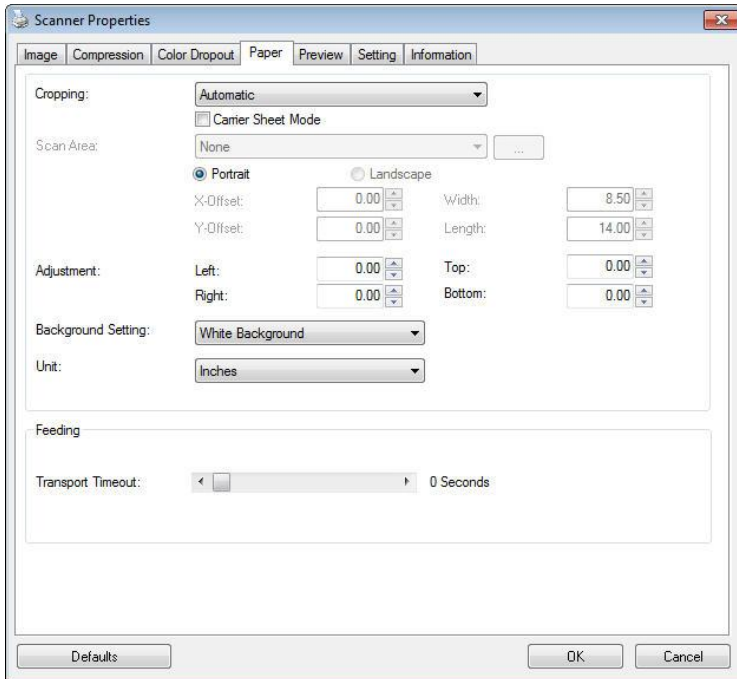

The Paper tab dialog box

4.6.1 Cropping

Cropping allows you to capture a portion of the document being scanned. **Choice: Automatic, Automatic (36"), Fixed to Transport, EOP (End of Page) Detection, Automatic Multiple, Relative to Documents.**

Options	Description
Automatic	Automatic adjusts the cropping window according to different document sizes and automatically straighten a skewed document. Use this option for batches of mixed-sized documents.
Automatic (36")	Automatically adjusts the cropping window according to different document sizes smaller than 36" and automatically straighten a skewed image. Use this option for batches of mixed-sized document. Note: The availability of this feature varies due to scanner model.
Fixed to Transport	This feature allows you to define the area or zone to be imaged. Use for batches of same-sized documents. If you select this option, you can use the arrow keys to define the x and y offset values, width and length to redefine your scanned area. The Display window will show image placement as you change the values.
EOP (End of Page) Detection	This feature allows you to define the area or zone to be imaged. Use for batches of same-width but different length documents. If you select this option, you can use the arrow keys to define the x and y offset values, width and length to redefine your scanned area. The Display window will show image placement as you change the values.

<p>Automatic Multiple</p>	<p>This option allows you to place various sized documents such as photos, ID Cards, or business cards on the flatbed (if available) and lets you create multiple individually cropped images in one scan. Note: To correctly create multiple images, please make sure there is at least 12mm (0.5") of space between each document.</p>
<p>Relative to Document</p>	<p>This option allows you to crop different areas on your documents and deliver these images in B&W, Gray, or Color separately. For example, there are applications which require you to store the entire document in B&W and a part of the document in color to save storage space. This is useful for documents where a photograph or signature appears in a consistent area on the document such as resumes, and so on.</p>

The following options are only available when **Fixed to Transport** is selected.

- **X-Offset** — the distance from the left end of the scanner to the left edge of the scanning area.
- **Y-Offset** — the position from the top end of the document to the top end of the scanning area.
- **Width** — the width of the scanning area.
- **Length** — the length of the scanning area.
- **Center:** automatically calculates the x-offset for center-fed feeding based upon document size selected.



- — relocate the scan area by click the arrow key on the cross sign while retain the scan size. View the result from the Display window.

The Adjustment option is available when **Automatic** is selected.

- **Adjustment** —adds a positive/negative margin value Top/Bottom or toward left/right of the image. Adjustment is used when the automatic document feeder is used. Adjustment reduces the possibility of corner clipping on skewed images. To set Adjustment values, use the UP/Down buttons to select where you want to apply Adjustment values: Top/Bottom or Left/Right, and then select the amount of inches/mm/pixels applied. Select a value within the range of 0.00 to 1.00 / -1.00.

Relative to Document: (used for batches of same-sized documents)

This option allows you to crop different areas on your documents and deliver these images in B&W, Gray, or Color separately. For example, there are applications which require you to store the entire document in B&W and a part of the document in color to save storage space. This is useful for documents where a photograph or signature appears in a consistent area on the document such as resumes, and so on.

The following procedure describes how to reproduce the entire document in B&W and a portion of document (picture) in color.

1. On the Paper tab, choose "Relative to Document" or "Fixed to Transport" from the Cropping option.
2. Choose your scan size from the Scan Area option. The selected scan size will be displayed in a red rectangular box. This is also the scan size of your entire document. (For example, ISO B5. If you have not chosen a scan area and leave the selection as None, then the default area will be the scanner's maximum.)

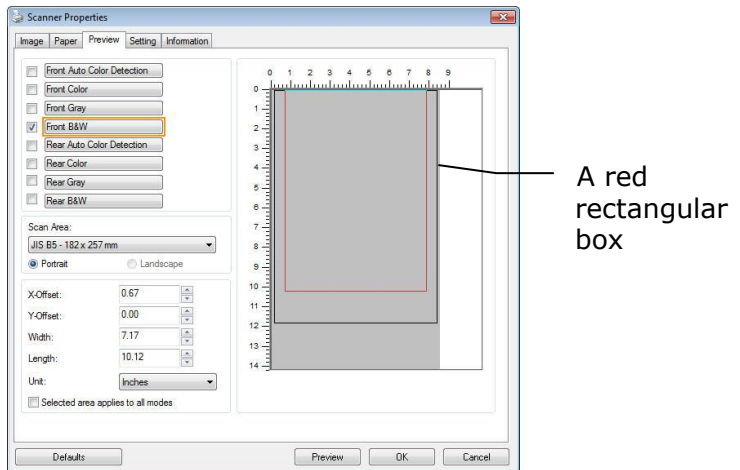

- Click the Preview tab to display the Preview window. A black rectangular box appears to indicate the max. scan size you have just selected.

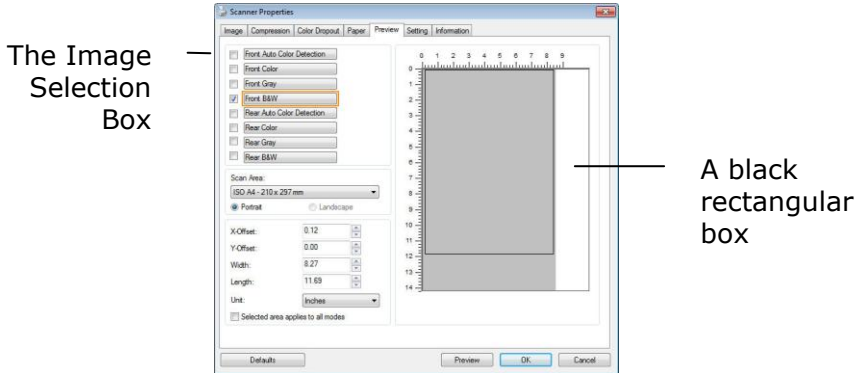

- Click the Preview button to view the entire image in low resolution to correctly crop your relative scan area.

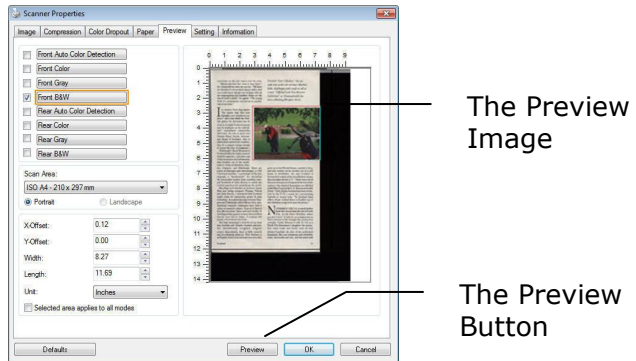

- Select image type from the Image Selection box. The selected image will appear in highlighted color. (For example, Front Color)
- Place your cursor on the Preview window and click your left mouse button. A cross sign will appear as illustrated. Create your relative scan size diagonally by dragging the left mouse button to your preferable size. The selected area will appear in a red box as illustrated.

A Cross Sign

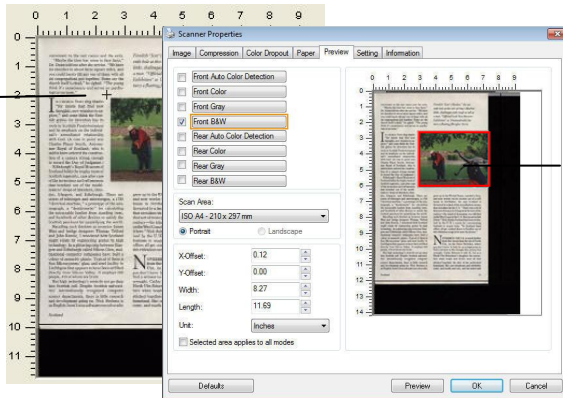

The Relative Area

7. Check the B&W image from the Image Selection box to scan the entire document.
8. Click the Scan button to start scanning the document in two image types and sizes. (See the result in below.)

conversion to the rest rooms and the suits. "Maybe the time has come to face facts," Dr. Davis said in after the service. "We have six churches in about three square miles, and you could barely fill any one of them with all six congregations and together." Some say the church itself is dead, "he sighed. "The young lady, it's unnecessary and serves no practical purpose."

Finland's "Sea's Maiden," the youngest child in the city of Uleppa-Malinke, challenges with rough as tall as a man. "Official Lead News Monitor Exhibition" at Dronningholm features a floating fiberglass Niznie.

It is crucial that they think the "the mind that that new thoughts, new wonders to explore," and some think the Scottish genius for invention has its roots in Scottish Presbyterianism and its emphasis on the individual's unencumbered relationship with God. (A case in point was Charles Piazzi Smith, Astronomer Royal of Scotland, who is said to have endorsed the construction of a camera strong enough to record the Day of Judgment.) Edinburgh's Royal Museum of Scotland holds the treasured remains of Scottish ingenuity, case after case of the invention and refinement that tumbled out of the modern-day shops of Aberdeen, Dundee, Glasgow, and Edinburgh. There are zones of telescopes and microscopes, a 1780 "electrical machine," a prototype of the telegraph, a "shovel-turner" for calculating the extractable lumber from standing trees, and hundreds of other devices to inspire the Scottish penchant for quantifying the world. Bending each finished as covered James Watt and bridge designer Thomas Telford and John Roanin, a renowned how Scotland might relate its engineering genius to high technology. Its a gathering between Glasgow and Edinburgh called Silicon Glen, multinational computer companies have built a colony of assembly plants. "Typical of them is Sun Microsystems' glass-enclosed facility in Edinburgh that appears to have been airlifted directly from Silicon Valley. It employs 600 people, 410 of whom are Scots. Big high technology roots do not go deep into Scottish soil. Despite Scottish universities' internationally recognized computer science departments, there's little research and development going on. Nick Chisholm is an English-born IT consultant who works for



grew up in the United States, married a Scot, and now works by his mother's side of a mill house in Perthshire. He says Scotland is threatened by a lack of the entrepreneurial energy that circulates in the U.S. "There was a lot of that in the 1960s and 1970s, but it's gone by the century—the kind of dynamism you still find in the West Coast of the U.S. They've never been there." Nick Chisholm (Scotland) has been victimized by the U.K.'s attitude for connecting business in major jobs. "In Scotland bond officers all get outed from the London set of this ridiculous urge to be near the throne."

Over the years, it is much further from the throne than the Isle of North. It is the Outer Hebrides, where, you don't have to look for an entrepreneur to find a witness to the changes this century has brought. Cathy Johnson is only 26, but as a North Uist Highlander's daughter she remembers when boats and ferries were all that stitched together the bits of her parched homeland. She can telephone her disability case, need needs and cars, and last winter and



The entire document in B&W

The relative area in color

4.6.2 Other Paper Selection

Carrier Sheet Mode:

Check this option to automatically crop the scan window according to your document size when scanning non-standard document (fragile, irregular-size document) with a carrier sheet (optional). Note: The availability of this option varies due to scanner model.

Loading Documents Using a Carrier Sheet

A Carrier Sheet is a plastic sheet specifically used for loading non-standard document onto the scanner. It allows you to scan document that can not be scanned in the regular way. Also, documents larger than A4 size, such as A3 and B4, can be scanned by folding in half, inserting into the Carrier Sheet, and scanning in duplex mode. You can also scan documents that can be damaged quite easily such as photographs, or irregular size documents that are difficult to load directly such as clippings.

To scan document using a Carrier Sheet,

For documents larger than A4/Letter size, such as A3

- a. Fold the sheet to be scanned in half.
- b. Fold the sheet tightly and smooth out crease. Otherwise, the sheet may be skewed during scanning.

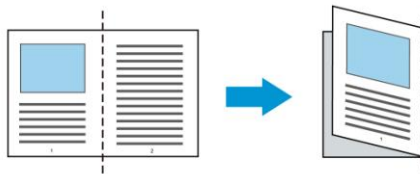

- 1. Open the Carrier Sheet and place the document inside.**

Align the top of the document to the top of the Carrier Sheet (the printed area).

For documents larger than A4/letter size, such as A3

Align the top of the document to the top of the Carrier Sheet (the printed section) and the folded portion to the right edge of the Carrier Sheet so that the document fits into the Carrier Sheet at the upper corner.

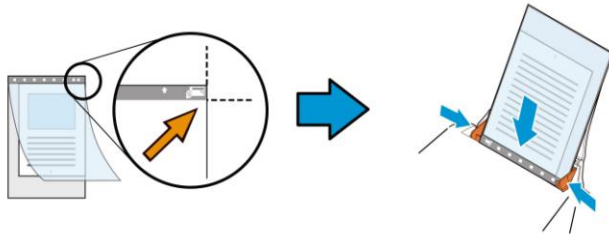

For non-standard document

Center your document in the Carrier Sheet.

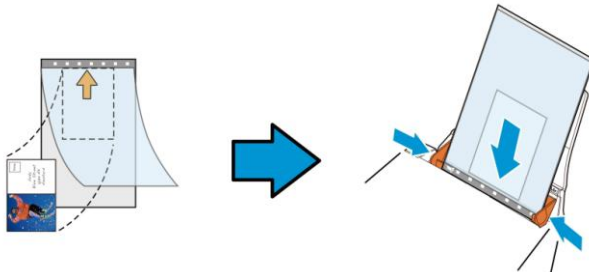

2. Load the Carrier Sheet with the gray section (printed section) facing downwards.
3. Adjust the paper guides to the width of the Carrier Sheet.
Adjust the paper guides so that there is no space between the guides and the Carrier sheet. Space between the guides and Carrier Sheet may cause the Carrier Sheet to become unaligned during scanning, and skew the scanned image.
4. Start the scan.

NOTE:

- [Carrier Sheet] is available for the models that support the Carrier Sheet.
- Some functions are disabled when [Carrier Sheet] is checked.
- This option may not work properly on some applications.

Scan Area

Choose your desired paper size with the drop-down list box. Or you may select a custom paper size by clicking the **Scan Area** box and then click **Add** to include in the choice.

Choices are listed below:

None
US Letter- 8.5"x 11"
US Legal – 8.5" x 14"
ISO A4 – 21 x 29.7 cm
ISO A5 – 14.8 x 21 cm
ISO A6 – 10.5 x 14.8cm
ISO A7 – 7.4 x 10/5 cm
ISO B5 – 17.6 x 25 cm
ISO B6 – 12.5 x 17.6 cm
ISO B7 – 8.8 x 12.5 cm
JIS B5 – 18.2 x 25.7 cm
JIS B6 – 12.8 x 18.2 cm
JIS B7 – 9.1 x 12.8 cm
Scanner Maximum
Long Page (<118")

Long Page (<118"):

When you need to scan documents whose length exceeds scanner maximum, please choose **Long Page**. Note if **Long Page** is selected, the **Multi-Feed Detection** will not be available. (Note: This option and the maximum allowable document length vary due to type of scanner.)

When **Long Page (<118")** is selected, be sure to specify your document size in the **Length** and **Width** field.

Notice when scanning long page document:

1. Pull out the extension in the ADF Paper Tray.
2. Secure enough space around the Output Tray to prevent the ejected paper from falling off the Output Tray.
3. To ensure the performance, in color mode, set the resolution to be 300 dpi or lower; in Black and White mode, set the resolution to be 600 dpi or lower.
4. Depending on your system environments, application, or your specified paper size, there may be insufficient memory to perform scanning.

OverScan

Overscan allows you to add a specific margin at top and bottom or right and left (Options vary based on the type of scanner) of the edge of the image. This is used to reduce possible corner clipping on the skewed images and often applied to a batch of skewed document to be scanned in the auto document feeder. Select a value between 0 and +5 mm. Note the overscan result will not be shown in the Display window and that the availability of the function varies based on type of scanner.

Pre-Feed

Choice: Enable, Disable. If enable is selected, you can set the amount of time the scanner starts pre-feeding your paper after your documents has been loaded into the feeder. The default is disable. Note: The availability of this option varies due to scanner model.

Transport Timeout

Set the amount of time the scanner will wait and then start auto scan after the first scan job is completed. If you have many separate documents need to be scanned at the same scan settings, this feature is especially useful. The default is 0. The value ranges from 0 to 30 seconds.

NOTE:

- Within the specified timeout period, if you load your document to the feeder, the scanner starts scanning automatically.
- If your scanner has a flatbed option and you place your paper on the flatbed, after the timeout period, you need to click the Scan button on the TWAIN user interface to start scanning.

Background Setting

This option allows you to set your scan background. **Choice: White Background, Black Background.**

Note: For a sheet-fed scanner with an auto document feeder, this option is currently available only in the "Auto crop" mode. For a scanner with a flatbed platen, this option is available either in the "Auto crop" or the "Fixed to Transport" mode.

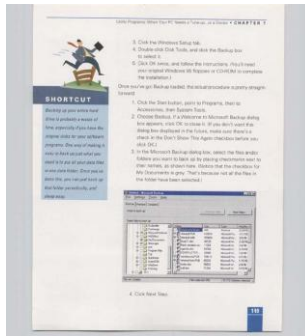

White Background

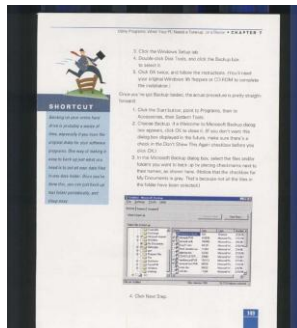

Black Background

4.7 The Multi-Feed Detection Tab

Multi-Feed Detection

Multi-Feed Detection allows you to detect overlapped document that go through the auto document feeder. Multi-Feed usually occurs due to stapled documents, adhesives on documents, or electro-statically charged document. Note : The availability of the function varies based on type of scanner.

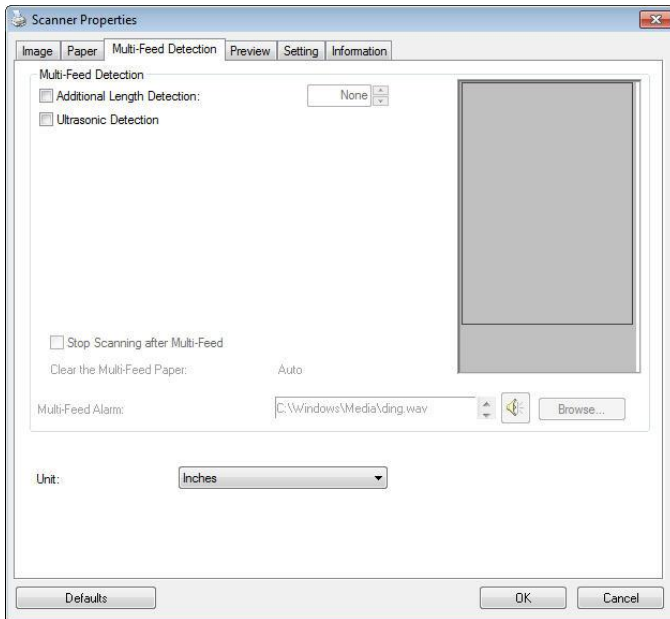

Additional Length Detection

Additional Length Detection allows you to define the length of document being multi-fed. This value indicates the additional length exceeding your scan area. The Display window will show the size of the document as you change the value. A value of 0 indicates no additional length detection. The Additional Length Detection is best used when scanning same-size documents in the auto document feeder.

Ultrasonic Detection

Ultrasonic Detection allows you to set overlapped document by detecting paper thickness between documents. Note : The availability of the function varies based on type of scanner.

● **Stop Scanning after Multi-Feed**

- If this is not selected, the scanner will continue scanning the rest document though multi-feed is detected. After the entire document has been scanned, a multi-feed dialog box will be prompted to indicate the page number which has been detected multi-feed and need to be rescanned.
- If this is selected, the following options will be displayed.

Stop: If this is selected, the scanner will stop scanning after a multi-feed is detected. No further dialog box will be prompted.

Ask: If this is selected, the image of the page which has been detected multi-feed will be displayed and three options are provided.

<p>➔ Continue Scan:</p>	<p>If the image of the multi-feed page is acceptable, select [Continue Scan] to continue scanning the rest pages.</p>
--------------------------------	--

<p>→ Continue Scan(Discard Image):</p>	<p>If the image of the multi-feed page is not acceptable, select [Continue Scan (Discard Image)] to scan the rest pages yet the multi-feed page will be ignored and you need to rescan the page again.</p>
<p>→ Stop Scan:</p>	<p>The scanner stop scans. Remove the remaining pages in the scanner. Remove staples or any adhesive tapes on your document. Or fan your document and rescan the rest pages.</p>

- **Multi-Feed Alarm**

If a wave file is added, the scanner will make a sound alarm if multi-feed is detected yet no Warning dialog box will be displayed.

How to add the sound alarm :

1. Click the Browse button on the right side of the speaker icon. The Open dialog box appears.
2. Choose your wave file.
3. Click the Open button. The wave file is added.

Units

Defines the primary measurement system. **Inches**, **Millimeters**, and **Pixels** are available.

4.8 The Preview Tab

The Preview tab allows you to preview (a low-resolution scan) your image before final scan. This preview image lets you allocate your scan area. You can choose your scan area by the "Scan Area" drop down list box or placing your cursor on the Display window and dragging it diagonally on the Display window. Then, a red rectangle box will appear to indicate the selected area.

Note: If you choose "Automatic Cropping" on the "Paper Tab", then to select a scan area on the Preview tab is not allowed.

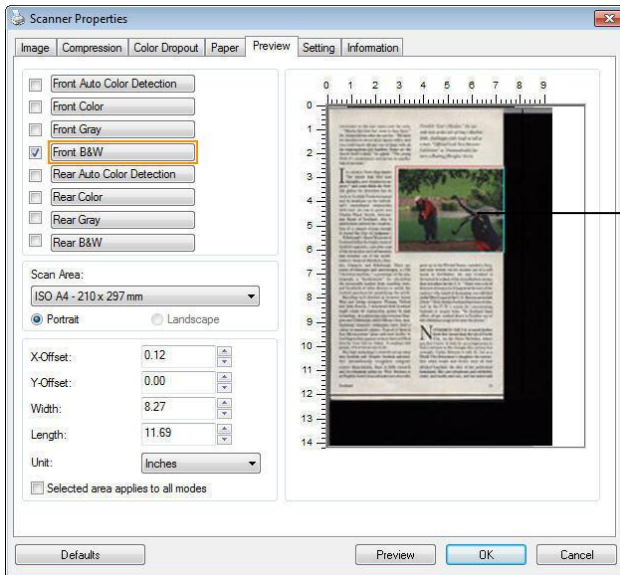

The Display Window

The Preview Tab

4.9 The Enhancement Tab

The Enhancement tab allows you to set following additional image processing settings.

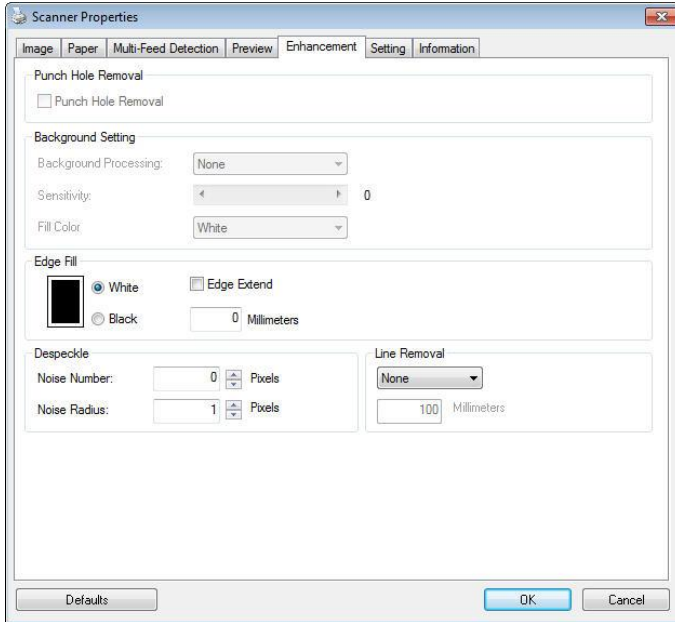

The Option tab dialog box

Punch Hole Removal

You can remove punch holes from the output scanned image when scanning punched document. Note the availability of this feature varies depending on your scanner model.

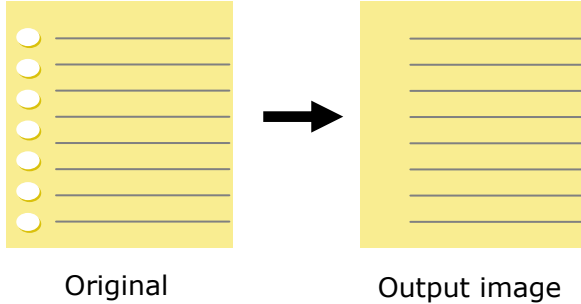

Punch holes can not be removed when:

- Resolution is set lower than 150dpi
- The hole is near the edge of the document
- The holes are not aligned along the edge of the document
- Punch Hole Removal is available only when "Auto Crop" is enabled. If either "Fixed to Transport", "EOP (End of Page) Detection", "Automatic Multiple", "Relative to Documents" is selected from the Cropping option on the Paper tab, the Punch Hole Removal option will be disabled.

Shadow Removal

When 「Flatbed」 on the 「Scan Source」 option is selected on the 「Image」 tab, the 「Shadow Removal」 option will be enabled. Click to remove the shadow on the book spine when scanning a book.



Before Shadow Removal

After Shadow Removal

Background Processing: The [**Background Processing**] option allows you to smooth background color or remove it to make image clearer. The option is especially useful for documents with color forms such as invoices.

Choices: None (default), Smooth, Removal

- **None** - no background processing will be performed (default)
- **Smooth** - produces images with a more uniform background color. This option improves image quality.
- **Removal** - identifies the background color and then removes it.

Sensitivity: Choice: 0, 1, 2, 3, 4. Default: 0

- The higher the value, the more background color will be kept.

Mode: Auto, Moiré

If [**Smooth**] is selected in the [**Background Processing**] option, then the choices for the [**Mode**] option includes Auto, and Moiré.

- **Auto** - uses the factory preprogrammed mode to proceed background smoothing.
- **Moiré** - Remove the moiré patterns that appear on the background of the image when scanning printed material.

If [**Removal**] is selected in the [**Background Processing**] option, then the [**Mode**] option will be replaced with [**Fill Color**]. Choices: White, Auto.

- **White** - identifies the background color and substitutes it with white.
- **Auto** - identifies the background color and substitutes it with the color of the largest background zone.

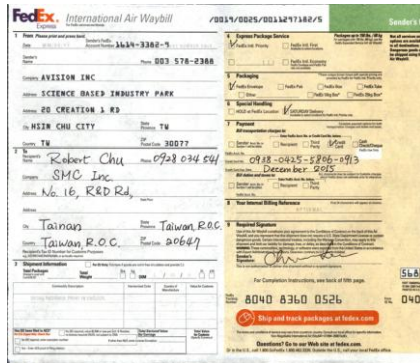

Background Processing: None



Background Processing:
Smooth



Background Processing:
Removal
Fill Color: White

NOTE:
Background color in small zone will not be processed or removed.

Edge Fill

Check White or Black if you wish to add white or black edge on the border of your scanned image. Enter the value from 0 to 5 mm. Default value is 0.

perforation

In order to remove dust from the top and bottom edges of the page, we have added a special feature, which allows you to add a white or black edge to the page.

Edge Fill Value

The value of Edge Fill is 0 mm by default. You can set it to 1, 2, 3, 4 or 5 mm. The value of Edge Fill is 0 mm by default.

The value of Edge Fill is 0 mm by default. You can set it to 1, 2, 3, 4 or 5 mm. The value of Edge Fill is 0 mm by default.

Edge Fill Value

The value of Edge Fill is 0 mm by default. You can set it to 1, 2, 3, 4 or 5 mm. The value of Edge Fill is 0 mm by default.

Original

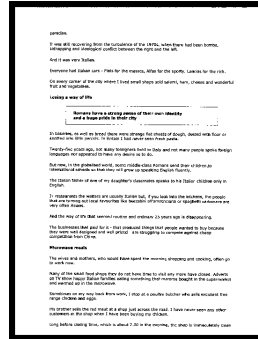

Edge Fill: 5mm (Black)

If you want to add a white or black frame on the edges of the scanned image, check "Edge Extension".

The default value is 0. The maximum value is half of the short side of the selected scan area. For example, if you choose an A4 size (8.26 "X11.69"), then the maximum value of the white or black box is 4.14" (half of "8.26").

Despeckle

Occasionally small dots or specks appear in the background of a scanned image. Remove unwanted speckles provides a cleaner image for OCR (Optical Character Recognition) processing, and also helps to reduce compressed file size.

Define the speckles (also known as image noise) you wish to remove by specifying its number (size) and radius (range). The measuring unit is pixel. The higher the number, the more speckles will be removed.

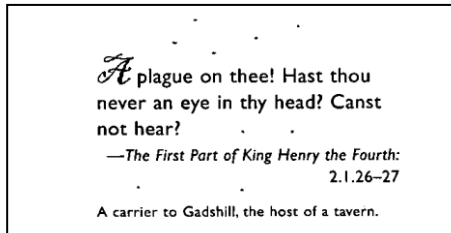

Before Despeckle (noise number:0, noise radius:1)

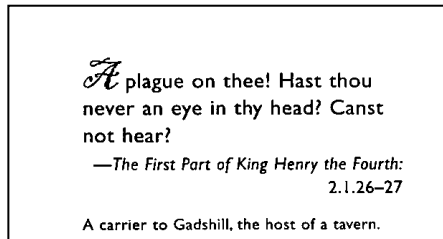

After Despeckle (noise number:22, noise radius:10)

NOTE:

- The function is currently available for Black and White image only.
- To scan at rated speed, it is recommended to set the noise radius up to 10 pixels.

Line Removal: When **Black and White** image mode is selected on the [Image] tab, the [Line Removal] option will be enabled. Line Removal erases lines on the image and then reconstructs characters so the OCR (Optical Character Recognition) accuracy can be improved.

Choices: None, Form, Horizontal, Vertical

None – the default mode which does not remove any line.

Form – remove any form in the document.

Horizontal – select [Horizontal] and then enter the length of horizontal line to remove only the horizontal line exceeding your specified length.

Vertical – select [Vertical] and then enter the length of vertical line to remove only the vertical line exceeding your specified length.

<p>Attn: Mr. David Wang</p> <p>Shipped by SST Technologies Inc. For U-Line Express</p> <p>Sailing on or about July 30, 2002 From Taiwan, R.O.C. to U.S.A.</p> <p>L/C No. Contract No. A1233</p> <table border="1" style="width:100%; border-collapse: collapse;"> <thead> <tr> <th>Marks & Nos.</th> <th>Description of Goods</th> <th>Quantity</th> <th>Unit Price</th> <th>Amount</th> </tr> </thead> <tbody> <tr> <td rowspan="3">ABC</td> <td>Amnret (Item No. 100)</td> <td>3 sets</td> <td>USD20.00</td> <td>USD60.00</td> </tr> <tr> <td>Amnret (Item No. 101)</td> <td>3 sets</td> <td>USD20.00</td> <td>USD60.00</td> </tr> <tr> <td>Amnret (Item No. 102)</td> <td>3 sets</td> <td>USD20.00</td> <td>USD60.00</td> </tr> <tr> <td colspan="2">Seattle P/O No. A1233 C/No. 1 Made in Taiwan, R.O.C.</td> <td></td> <td></td> <td></td> </tr> <tr> <td colspan="2">Total</td> <td>9 sets</td> <td></td> <td>USD180.00</td> </tr> </tbody> </table>	Marks & Nos.	Description of Goods	Quantity	Unit Price	Amount	ABC	Amnret (Item No. 100)	3 sets	USD20.00	USD60.00	Amnret (Item No. 101)	3 sets	USD20.00	USD60.00	Amnret (Item No. 102)	3 sets	USD20.00	USD60.00	Seattle P/O No. A1233 C/No. 1 Made in Taiwan, R.O.C.					Total		9 sets		USD180.00	<p>Attn: Mr. David Wang</p> <p>Shipped by SST Technologies Inc. For U-Line Express</p> <p>Sailing on or about July 30, 2002 From Taiwan, R.O.C. to U.S.A.</p> <p>L/C No. Contract No. A1233</p> <table border="1" style="width:100%; border-collapse: collapse;"> <thead> <tr> <th>Marks & Nos.</th> <th>Description of Goods</th> <th>Quantity</th> <th>Unit Price</th> <th>Amount</th> </tr> </thead> <tbody> <tr> <td rowspan="3">ABC</td> <td>Amnret (Item No. 100)</td> <td>3 sets</td> <td>USD20.00</td> <td>USD60.00</td> </tr> <tr> <td>Amnret (Item No. 101)</td> <td>3 sets</td> <td>USD20.00</td> <td>USD60.00</td> </tr> <tr> <td>Amnret (Item No. 102)</td> <td>3 sets</td> <td>USD20.00</td> <td>USD60.00</td> </tr> <tr> <td colspan="2">Seattle P/O No. A1233 C/No. 1 Made in Taiwan, R.O.C.</td> <td></td> <td></td> <td></td> </tr> <tr> <td colspan="2">Total</td> <td>9 sets</td> <td></td> <td>USD180.00</td> </tr> </tbody> </table>	Marks & Nos.	Description of Goods	Quantity	Unit Price	Amount	ABC	Amnret (Item No. 100)	3 sets	USD20.00	USD60.00	Amnret (Item No. 101)	3 sets	USD20.00	USD60.00	Amnret (Item No. 102)	3 sets	USD20.00	USD60.00	Seattle P/O No. A1233 C/No. 1 Made in Taiwan, R.O.C.					Total		9 sets		USD180.00
Marks & Nos.	Description of Goods	Quantity	Unit Price	Amount																																																					
ABC	Amnret (Item No. 100)	3 sets	USD20.00	USD60.00																																																					
	Amnret (Item No. 101)	3 sets	USD20.00	USD60.00																																																					
	Amnret (Item No. 102)	3 sets	USD20.00	USD60.00																																																					
Seattle P/O No. A1233 C/No. 1 Made in Taiwan, R.O.C.																																																									
Total		9 sets		USD180.00																																																					
Marks & Nos.	Description of Goods	Quantity	Unit Price	Amount																																																					
ABC	Amnret (Item No. 100)	3 sets	USD20.00	USD60.00																																																					
	Amnret (Item No. 101)	3 sets	USD20.00	USD60.00																																																					
	Amnret (Item No. 102)	3 sets	USD20.00	USD60.00																																																					
Seattle P/O No. A1233 C/No. 1 Made in Taiwan, R.O.C.																																																									
Total		9 sets		USD180.00																																																					
None	Remove Form																																																								
<p>Attn: Mr. David Wang</p> <p>Shipped by SST Technologies Inc. For U-Line Express</p> <p>Sailing on or about July 30, 2002 From Taiwan, R.O.C. to U.S.A.</p> <p>L/C No. Contract No. A1233</p> <table border="1" style="width:100%; border-collapse: collapse;"> <thead> <tr> <th>Marks & Nos.</th> <th>Description of Goods</th> <th>Quantity</th> <th>Unit Price</th> <th>Amount</th> </tr> </thead> <tbody> <tr> <td rowspan="3">ABC</td> <td>Amnret (Item No. 100)</td> <td>3 sets</td> <td>USD20.00</td> <td>USD60.00</td> </tr> <tr> <td>Amnret (Item No. 101)</td> <td>3 sets</td> <td>USD20.00</td> <td>USD60.00</td> </tr> <tr> <td>Amnret (Item No. 102)</td> <td>3 sets</td> <td>USD20.00</td> <td>USD60.00</td> </tr> <tr> <td colspan="2">Seattle P/O No. A1233 C/No. 1 Made in Taiwan, R.O.C.</td> <td></td> <td></td> <td></td> </tr> <tr> <td colspan="2">Total</td> <td>9 sets</td> <td></td> <td>USD180.00</td> </tr> </tbody> </table>	Marks & Nos.	Description of Goods	Quantity	Unit Price	Amount	ABC	Amnret (Item No. 100)	3 sets	USD20.00	USD60.00	Amnret (Item No. 101)	3 sets	USD20.00	USD60.00	Amnret (Item No. 102)	3 sets	USD20.00	USD60.00	Seattle P/O No. A1233 C/No. 1 Made in Taiwan, R.O.C.					Total		9 sets		USD180.00	<p>Attn: Mr. David Wang</p> <p>Shipped by SST Technologies Inc. For U-Line Express</p> <p>Sailing on or about July 30, 2002 From Taiwan, R.O.C. to U.S.A.</p> <p>L/C No. Contract No. A1233</p> <table border="1" style="width:100%; border-collapse: collapse;"> <thead> <tr> <th>Marks & Nos.</th> <th>Description of Goods</th> <th>Quantity</th> <th>Unit Price</th> <th>Amount</th> </tr> </thead> <tbody> <tr> <td rowspan="3">ABC</td> <td>Amnret (Item No. 100)</td> <td>3 sets</td> <td>USD20.00</td> <td>USD60.00</td> </tr> <tr> <td>Amnret (Item No. 101)</td> <td>3 sets</td> <td>USD20.00</td> <td>USD60.00</td> </tr> <tr> <td>Amnret (Item No. 102)</td> <td>3 sets</td> <td>USD20.00</td> <td>USD60.00</td> </tr> <tr> <td colspan="2">Seattle P/O No. A1233 C/No. 1 Made in Taiwan, R.O.C.</td> <td></td> <td></td> <td></td> </tr> <tr> <td colspan="2">Total</td> <td>9 sets</td> <td></td> <td>USD180.00</td> </tr> </tbody> </table>	Marks & Nos.	Description of Goods	Quantity	Unit Price	Amount	ABC	Amnret (Item No. 100)	3 sets	USD20.00	USD60.00	Amnret (Item No. 101)	3 sets	USD20.00	USD60.00	Amnret (Item No. 102)	3 sets	USD20.00	USD60.00	Seattle P/O No. A1233 C/No. 1 Made in Taiwan, R.O.C.					Total		9 sets		USD180.00
Marks & Nos.	Description of Goods	Quantity	Unit Price	Amount																																																					
ABC	Amnret (Item No. 100)	3 sets	USD20.00	USD60.00																																																					
	Amnret (Item No. 101)	3 sets	USD20.00	USD60.00																																																					
	Amnret (Item No. 102)	3 sets	USD20.00	USD60.00																																																					
Seattle P/O No. A1233 C/No. 1 Made in Taiwan, R.O.C.																																																									
Total		9 sets		USD180.00																																																					
Marks & Nos.	Description of Goods	Quantity	Unit Price	Amount																																																					
ABC	Amnret (Item No. 100)	3 sets	USD20.00	USD60.00																																																					
	Amnret (Item No. 101)	3 sets	USD20.00	USD60.00																																																					
	Amnret (Item No. 102)	3 sets	USD20.00	USD60.00																																																					
Seattle P/O No. A1233 C/No. 1 Made in Taiwan, R.O.C.																																																									
Total		9 sets		USD180.00																																																					
Remove Horizontal Line (over 30 mm)	Remove Vertical Line (over 70 mm)																																																								

4.10 The Rotation Tab

The Rotation tab allows you to set the following image rotating options:

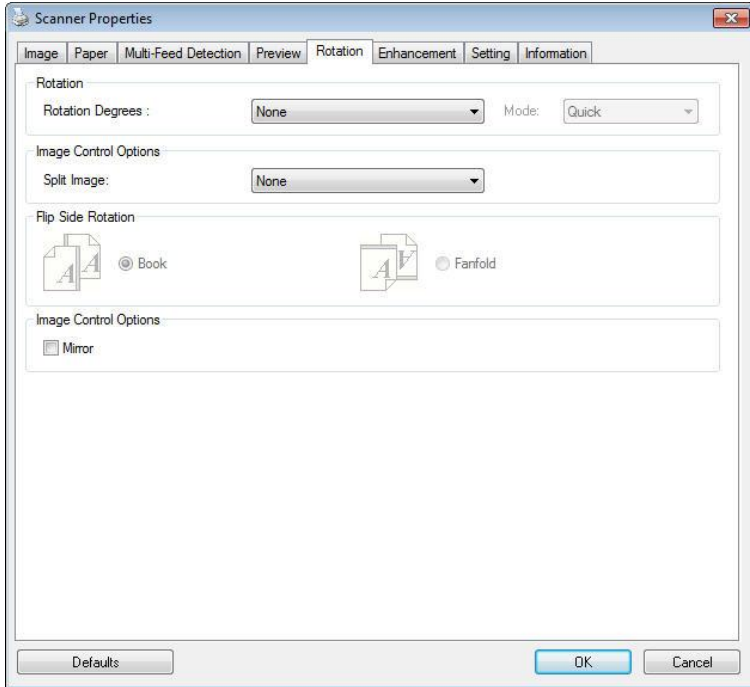

Rotate Image

Choose the rotation angle from the drop down list if you wish to rotate your scanned image.

Choice: None, 90°CW(clockwise), 90°CCW(counter clockwise), 180°, Auto based on contents. Auto rotate every even page.

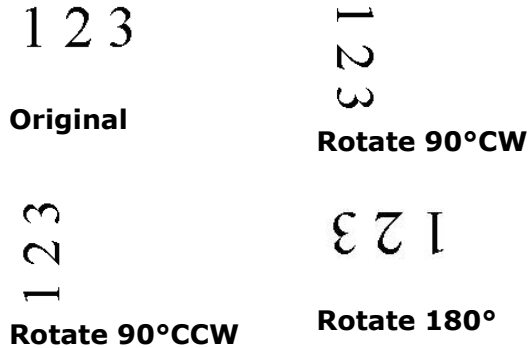

Auto based on contents: Automatically rotate images based on the contents of document. When 「**Auto based on contents**」 is selected, its modes will be enabled to let you select more options.

Mode: Quick, Full Text, Complexity

Quick – the default mode to let you rotate images at the fastest speed.

Full Text – the enhanced mode for documents with mixed text orientation.

Complexity – the enhanced mode yet at the slowest speed for document with complex image or text orientation.

Auto rotate every even page:

Automatically rotate 180° on every even page. This is especially useful when you scan the inside pages from a book. As a result, if you choose "Flatbed (book)" from the "Scan Source" option, "auto rotate every even page" will be selected as default.

Note: This option varies based on type of scanner.

	
<p>Document with various text orientations</p>	<p>Document with dark or complex background</p>

Split Image

By splitting an image, two separate images are created horizontally or vertically. This is useful for documents containing two pages per image when you want to save them as two images (one page for one image). **Choice: None, Horizontal, Vertical.** Default is None.

Horizontal: Divide one image into the upper half and the lower half.

Vertical: Divide one image into the left half and the right half.



Split Horizontally



Split Vertically

**Image
Control
Option**

Check the Mirror box if you wish to reverse the right and left side of your image.



Original



The Mirror Effect

4.11 The Separation Tab

The Separation tab allows you to enable the detection engine to detect the blank page, barcode, and patch code and then notify the software application which supports document separation to separate your multi-page documents. Choices: Blank Page Removal, Barcode Detection, Patch Code Detection.

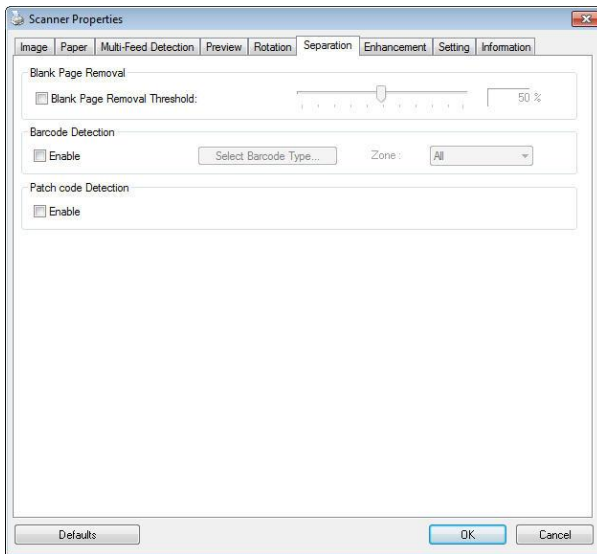

Blank Page Removal

Choices: None, Blank Page Removal Threshold, Image Size.

None – Do not remove the blank pages.

Threshold - Move the slider to the left or right to define your threshold for the blank page.

Image Size – Range: 1~ 10000 KB. Specify your desired image size to detect the page as a blank page. For example, if 3 KB is selected, any page less than 3 KB will be recognized as blank page.

**Barcode
Detection**

Check [**Enable**] to detect barcode and notify the software application for advanced processing. Please note the whole document will be checked and no specific detection area needs to be designated.

When the bar code has been detected successfully , a file [avbarcode.ini] will be created and stored in the following path:

Windows XP: C:\Documents and Settings\All Users\Application Data\%PRODUCTNAME%

Vista, Windows 7, Windows 8, Windows 10:
C:\ProgramData\%PRODUCTNAME%

Barcode Types:

The following barcode types can be detected.

Two-dimensional codes

- Aztec
- DataMatrix
- PDF417
- QR Code

One-dimensional barcodes:

- Add-2
- Add-5
- Australian Post 4-State
- BCD Matrix
- Codabar
- Code 128
- Code 32
- Code 39
- Code 93
- DataLogic 2 of 5
- EAN 128

- EAN-13
- EAN-8
- GS1 DataBar
- Industrial 2 of 5
- Intelligent Mail
- Interleaved 2 of 5
- Inverted 2 of 5
- IATA 2 of 5
- Matrix 2 of 5
- PostNet
- Royal Post 4-State
- UPC-A
- UPC-E

NOTE:

- Recommended resolution: 200~600 dpi for regular barcode, 300~600 dpi for QR code.
- Skewed barcodes may not be recognized correctly.
- Using the same sheet repeatedly may decrease the recognition accuracy due to accumulated dirt on the sheets. If the sheet is not recognized correctly or gets smudged, replace it with a new sheet.

Barcode Zone:

Specify the barcode zone to be detected.

Select 「**All**」 to checks the whole document and detects barcodes. Or you may speed up the process by specifying a detection area since only the specified area is checked.

Choice: All, Top, Bottom, Left, Right, Bottom Right, Bottom Left, Top Right, Top Left

Choice for barcode zone on a page:

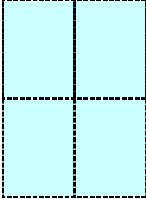
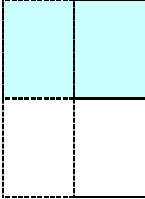
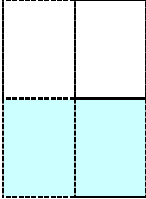
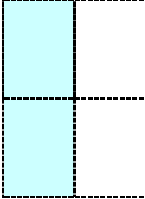
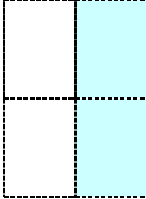
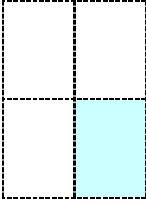
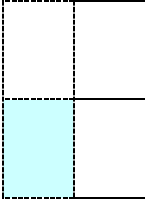
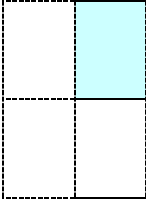
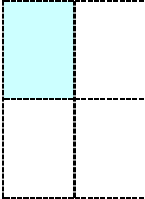
				
All	Top	Bottom	Left	Right
				
Bottom Right	Bottom Left	Top Right	Top Left	

Patch code Detection:

Check [**Enable**] to detect patch codes and notify the software application for advanced processing.

A patch code is a pattern of parallel, alternating black bars and spaces (i.e. a barcode) that is printed on a document. Patch code sheet is most commonly used as a document separator in a stack of document.

You can find various sizes of patch codes (PDF) by choosing [Start] menu>[All Programs]>[Avision Scanner Series]>[Patch code] in succession.

Simply print the PDF file to produce the patch code sheet. Insert the patch code sheets to wherever you want the file to separate.



Patch code sheet

NOTE:

- Use blank white paper.
- Set the scaling to 100%. The sheet is not recognized correctly when printed in a size smaller than the original.
- Do not use toner saving mode. The sheet is not recognized correctly when the print is too light.
- Do not use thin paper in order to avoid bleed-through from the back.
- When you copy a patch code sheet that you printed out, make sure to copy by the same size and brightness as the original copy.
- Use the same sheet repeatedly may decrease the recognition accuracy due to accumulated dirt on the sheets. If the sheet is not recognized correctly or gets smudged, replace it with a new sheet.

4.12 The Setting Tab

The Setting tab allows you to set the following settings:

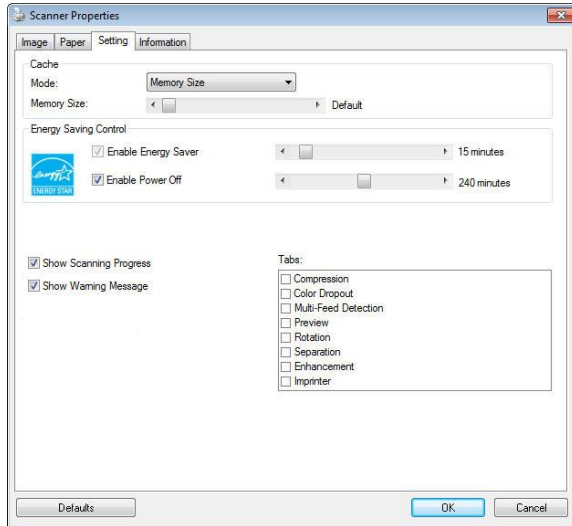

The Setting tab dialog box

<p>Energy Saving Control</p>	<p>Check the Enable Energy Saver box and move the slider to set the amount of time to start the energy saver after your last action. The range is from 1 to 60 minutes.</p>
<p>Enable Power Off</p>	<p>Check the Enable Power Off box and move the slider to set the amount of time to automatically turn off the scanner after your last action. The range is from 1 to 480 minutes. The default is 240 minutes (4 hours). Note the value of "Power Off" has to be greater than or equal to the value of "Energy Saving".</p>

Cache	<p>Mode: None, Page Number, Memory Size.</p> <p>This option allows you to assign a specified memory size from the available RAM to process the image data. By specifying a smaller memory size, you can free more memory for other applications you are running. By specifying a larger memory size, you can have more memory to process the image data especially when you have a large amount of documents needed to be scanned.</p> <p>You can also specify your memory size by the page number. For your information, an A4 color document scanning at 300 dpi consumes approximates 24MB.</p> <p>Image Count</p> <p>When the selected cache mode is "none", the image count option allows you to assign number of pages you need to scan. For example, if you wish to scan the first two pages, simply move the page slider to 2, and the scan action will be stopped when the scanning of the first two pages have been completed.</p>
--------------	--

Show Scanning Progress	Check and the scanning progress bar will be shown during scanning.
Show Warning Message	Check to show the warning messages such as "ADF pad count exceeds 50,000 scans (the number varies based on type of scanner). Please replace the ADF pad and reset the pad count."
Save Settings after Closing	Check to save your scanner properties settings after leaving the dialog box. Next time when you open the Scanner Properties dialog box, the previously saved settings will be shown.

4.13 The Imprinter Tab

The Imprinter tab allows you to print alphanumeric characters, date, time, document count and custom message on your scanned image if digital imprinter is selected or at the back of your document if external imprinter is selected.

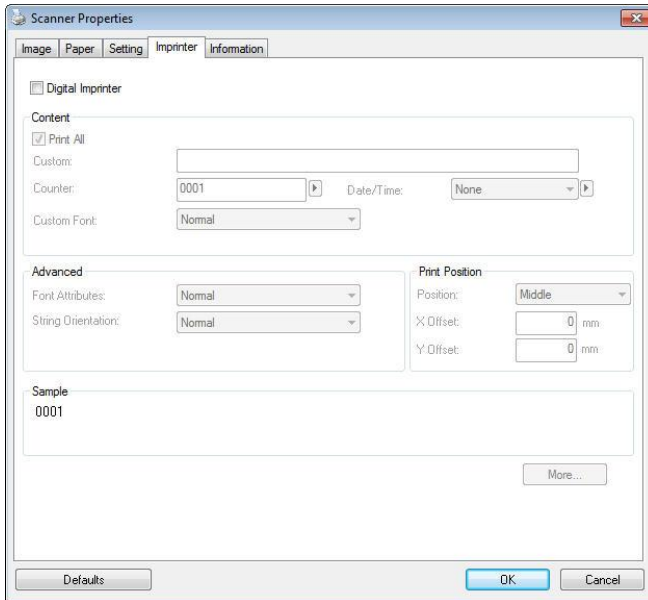

Choice: External Imprinter, Digital Imprinter. If you have installed an external imprinter, choose external imprinter. If you do not have an imprinter, choose digital imprinter. Note External Imprinter provides a vertical and rear-side print capability while digital printer provides a horizontal and front-side print capability.

Contents

Print All	Check Print All to automatically print the text at all pages of your documents. Uncheck Print All to print the text for the first page of your documents only.
Custom	Enter your custom text to be included in your print string.
Counter	Show the document count for the scan session. This value is increased sequentially by the scanner.

Date/Time	Choose if you wish to include the date and time in your print string. Format: YYYYMMDDHHSS For example, 20090402170645-check0001 indicates year, month, date, hour, seconds, your custom text and the counter.
Custom Font	Choose your desired font. Choice: Normal, Fixed Width Fixed Width (Mono spaced) fonts have a fixed character spacing. So each character occupies the same width.

Advanced

Font Attributes	Choose your font attributes. Choice: Normal, Underline, Double, and Bold.
------------------------	--

String Orientation	Choose your string orientation. Choice: Normal, Rotated, Vertical, Vertical Inversion, 90 degrees CW, 90 degrees CCW	
	2010abc Normal	2010abc Rotated
	2010abc Vertical	2010abc Vertical Inversion
	2010abc 90 degrees CW	2010abc 90 degrees CCW

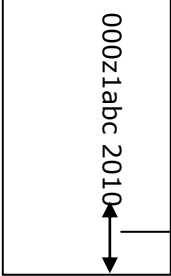
<p>Print Position</p>	<p>Choose the position you wish to print your string. Move the slider to the right to increase the value or to the left to decrease the value. Range: 0~355mm, default:0 mm The value indicates the height from the bottom of your paper to the last letter of your string. This option is available only if an external imprinter is installed.</p> <div style="text-align: center;">  <p>The value of Print Position</p> </div>
------------------------------	--

Print Position (for digital imprinter)

Choose the position of your printed string. **Choice: Top, Middle, Bottom, Custom.** If Custom is selected, enter the X and Y offset value to specify the position.

More: Click the [More] button to display more font options. This option is available for digital imprinter (stamp text on your scanned image) only. This function is not available on some models.

Font size: Move the slider to change the font size from 1 to 10. **Density:** Move the slider to change the source density from 0 to 255. The selected density will appear at the same time.

Transparency: Move the slider to choose an appropriate transparency value from 0% (not transparent) to 100% (completely transparent) so that your text can be partially transparent and you can see the background image.

4.14 The Information Tab

The Information tab displays the following system and scanner information.

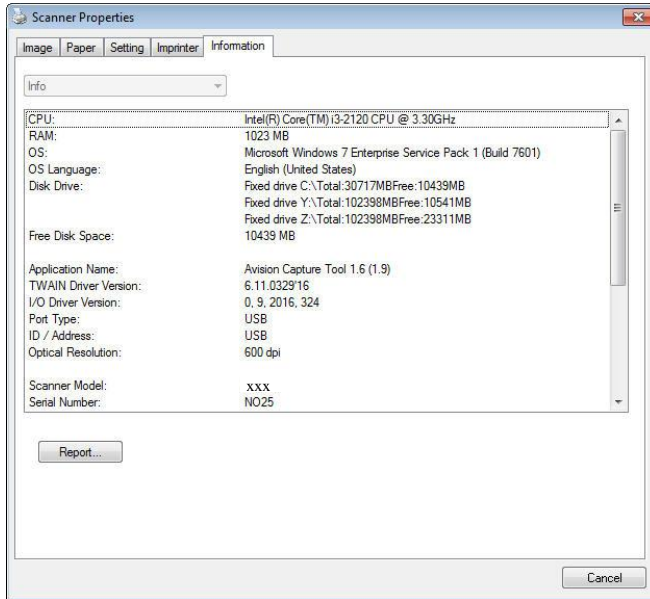

The Information tab dialog box

The "Report" button :

If you encounter any error message while using the scanner, click the Report button. A report.txt file [[Windows XP](#): C:\Documents and Settings\All Users\Application Data\%PRODUCTNAME%; [Vista, Windows 7, Windows 8, Windows 10](#): C:\ProgramData\%PRODUCTNAME% (C: system drive)] will be generated. Please send this file to the nearest service center for trouble shooting.

5. Using the Buttons

5.1 Installing PaperAir

Download PaperAir software application on our website at <http://avision.com/download>

The PaperAir application provides you an easy way to scan your document and then link the scanned image to your designated software application. All this can be done by a simple touch of the button on the scanner. Yet, before you scan, it is recommended to check the button configurations first to ensure a proper file format and a destination application.

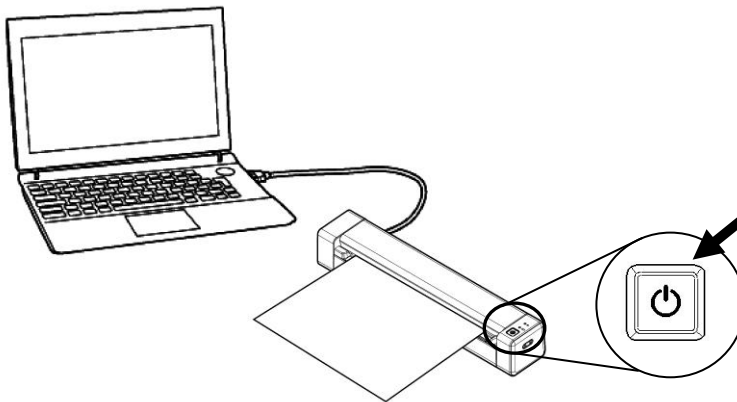

5.2 Checking the Button Configurations before Scanning

1. Make sure that the scanner driver has been installed on your computer, the scanner has been connected to your computer, and the scanner has been turned on.
2. After the PaperAir software application has been properly installed, the PaperAir will be automatically started. The main window of PaperAir will be displayed and the PaperAir icon will be displayed both on the Start menu and the toolbar as shown in below.

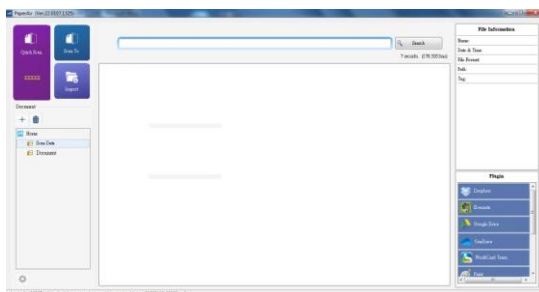

The main window of PaperAir



PaperAir icon will be displayed at the Start menu and the toolbar.

2. Right-click the [**Quick Scan**] button. A default [**Scan Setting**] dialog box will be displayed.

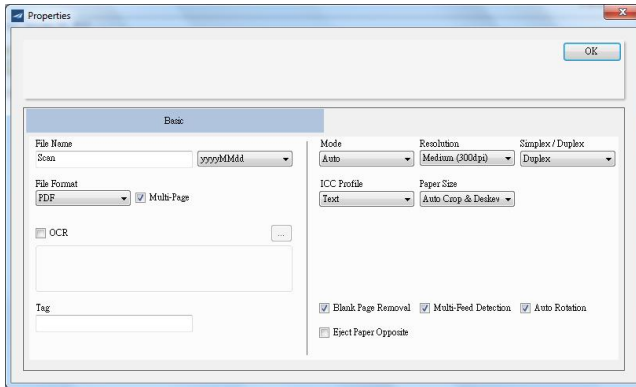

If you wish to change the setting, use this window to reset the setting for the file format, destination application, or other scan settings.

3. Click the OK button to leave the window.

5.3 Scanning From One Touch of the Buttons

1. Load paper into the feeder.
2. Click the **Quick Scan** button on the main window of PaperAir.
Or press the **Power** button on the scanner.
3. In a second, a thumbnail image of your document will be displayed.

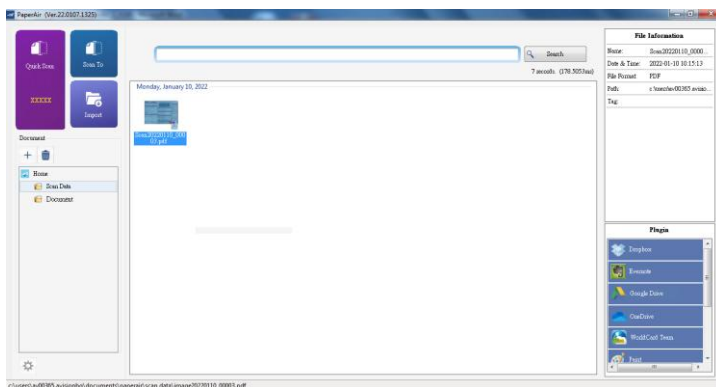

Note:



For more detailed information on how to use PaperAir, please refer to the user's manual. You may download the user's manual on our web site at www.avision.com/download.

6. Starting a Scan from Your Mobile Device

With a built-in Wi-Fi module, the scanner can be converted into a wireless device. When a mobile device is use, the scanned images can be received from the mobile device.

6.1 Making Preparation

- **PaperAir Application**
Download the **PaperAir Application** on your mobile device from an application store such as Google Play.

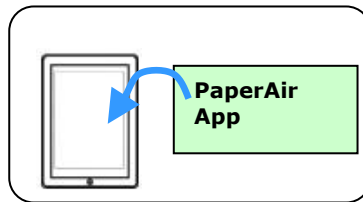

6.2 Connecting to a wireless network

In AP (Access Point) mode, your mobile devices and the scanner are connected wirelessly without an additional AP (Access Point) since the scanner itself works as an AP.

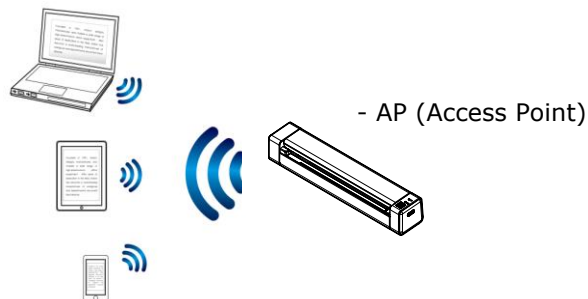

1. To turn on the Wi-Fi connection, slide the Wi-Fi switch to the **[On]** position. If the connection is successful, the Wi-Fi LED light will be lit solidly in blue.

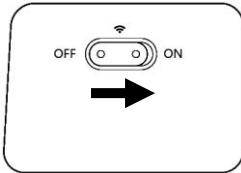

2. On your mobile devices, make sure Avison-xxxx (xxxx indicates the last four digits of the Mac Address at the back of the scanner) has been selected as your network name (SSID).

6.3 Scanning a document from a mobile device

Make sure that the **PaperAir Application** (Scan App) has been installed on your mobile device. The **PaperAir Application** can be purchased for free from an application store such as Google Play.

1. Enable **[Wi-Fi]** from **[Settings]** of your wireless computer, smartphone, or tablet and then choose the same network name (SSID) of your scanner.

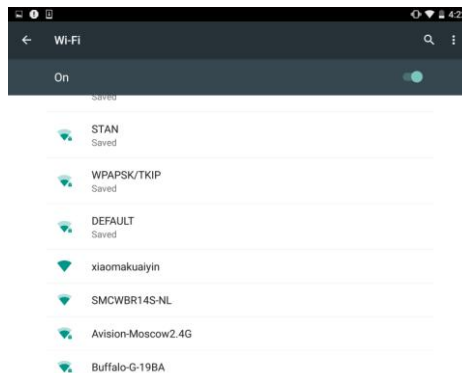

2. Tap the **PaperAir App** () on the screen to launch the Scan Application. The main window will be displayed and the application will automatically search a scanner in the same wireless LAN. If successful, [**Start scan**] will be displayed at the bottom as shown below.

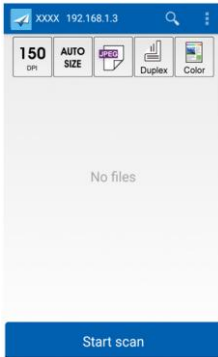

ATTENTION:

If the scanner is not found, please check the followings:

1. The scanner is not ready yet. Tap [**More Settings**] and then [**Search scanner**] to search the scanner again.
2. Check if the mobile device and the scanner are in the same wireless LAN.

3. Check if the default settings meet your requirements. If not, change the scan settings to fit your specific scanning task.

ITEM DESCRIPTION

200
DPI

Resolution: Select your desired resolution. The higher resolution, the greater the image quality and disk space.

Choice: *150, 200, 300 dpi

AUTO
SIZE

Scan Size: Select your paper size or you may choose Auto to let the scanner detect your document size automatically.

Choice: *Auto size, A4, LTR (Letter), LGL (Legal), 4x6, 5x7

 File Format: Select the file format for your image.
Choice: *JPEG, PDF, TIFF
Note: The JPEG file does not support the B&W image.

- The TIFF file format supports only the B&W image.

 Select to scan the front side (simplex) or both the front side and the rear side (duplex) of your document.
Choice: *Simplex, Duplex
Note: The duplex mode is available to scan from the auto document feeder only.

 Color Mode: Select your desired image mode.
Choice: *Color, B&W, Gray

* Default settings

4. Load a page to the auto document or place a page on the flat bed.
5. Tap the [**Start scan**] button. (Choose your scanner if there is more than one scanner connected to the network). In a second, the scanner begins scanning the document and the thumbnail scanned image will be displayed.

The
Thumbnail
Image

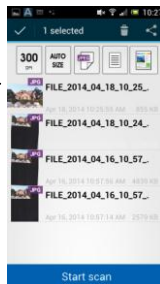

6. Tap the thumbnail image to view the entire image.

7. Maintenance

7.1 Calibrating the scanner

Calibrate only if the scanned image looks fuzzy, the color looks abnormal (e.g., darker than normal), after more than 8,000 scans, or the scanner has been stored without use for a long time. The calibration process resets the Contact Image Sensor to resume its color and sharpness precision.

1. Turn on the scanner.
2. Start your TWAIN-compliant image editing software application such as Avision Capture Tool by choosing Start>Programs>Avision XXXX Scanner>Avision Capture Tool (XXXX indicates your scanner model). The Select Scanner Model dialog box will be displayed.
3. Select your driver type and scanner model and click OK. The Avision Capture Tool dialog box will be displayed.
4. Click the **"Setup"** button to prompt the TWAIN user interface.
5. Click the **"Settings"** tab and then click the **"Calibration"** button. An **"Insert calibration sheet"** dialog box appears.
6. Hold the edges of the calibration sheet (*included*) and insert it with the *text face up* as shown.

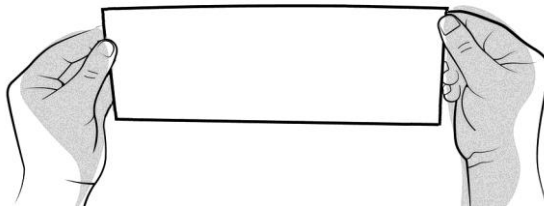

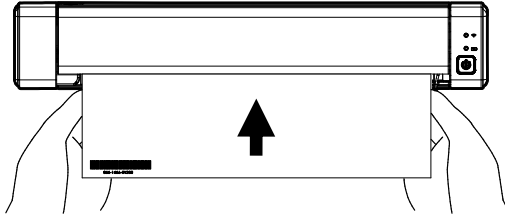

7. Click the **"OK"** button on the **"Insert calibration sheet"** dialog box to start calibrating the scanner.
8. Wait until the calibration has been finished.

WARNING:

- Do not interrupt the calibration sequence or try to shut off the device while it is calibrating.
- Calibrate the scanner only when color of the scanned image looks abnormal.
- Keep the calibration sheet from dust and debris. Any dirt may make the calibration chart invalid or impact the calibration result.
- Use only the included calibration sheet to calibrate the scanner.

7.2 Cleaning the scanner

In order to maintain the scanned image quality and prevent dust accumulation, it is recommended that you clean the scanner (*outer casing and feed rollers*) approximately every 200 scans, or if vertical lines or stripes appear on the scanned image.

WARNING: Do not use any solvents or corrosive liquid (*i.e., alcohol, kerosene, etc.*) to clean any part of the scanner, otherwise the plastic material may be permanently damaged.

1. Open the cover by holding the scanner with one thumb placing on the feeder and another thumb placing on the cover. Carefully and firmly press your thumb into the feeder and then raise the cover. This will cause the top of the scanner to release from the bottom of the scanner.

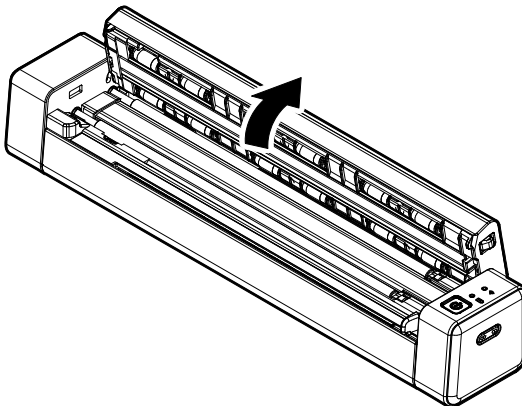

2. Gently wipe the glass and feeding rollers on the scanner, and the CIS cover with the cleaning cloth.

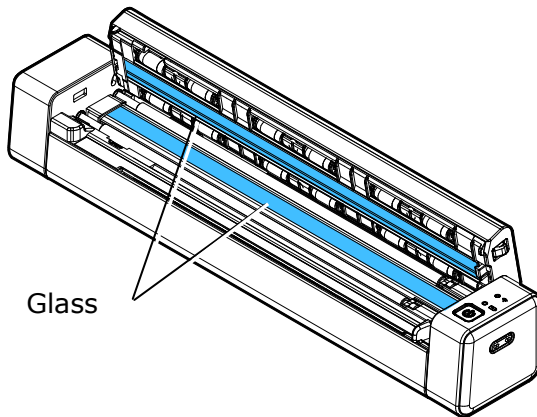
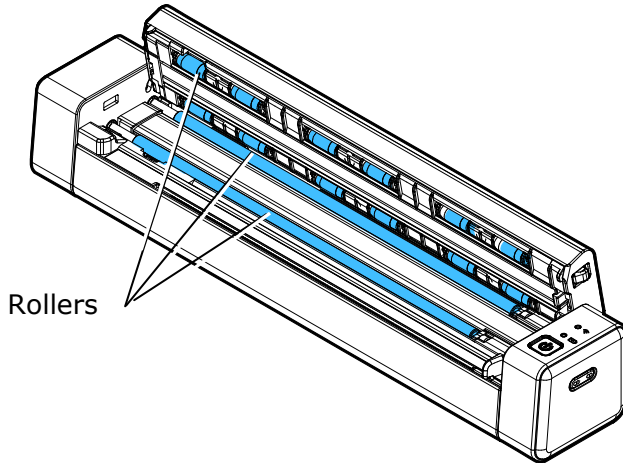

8. Troubleshooting

8.1 Clearing the Error Conditions

If there is error during scanning, the LED light will be flashing in red color. Refer to the following table to clear the error conditions.

The Number of Times the Red LED Blinks	Description	How to restore
4 (Continued)	Paper jam	Remove paper and try again. The Red LED light does not stop blinking unless the paper is removed.
6 (Continued)	Cover open	Close cover and then try again. The RED LED light does not stop blinking unless the cover has been closed.

**Warning:**

If the battery power is lower than 25%, the battery LED light will be blinking in red. Please recharge the battery to prevent possible incomplete scanned images or other operational problems.

8.2 Clearing a Paper Jam

1. Open the cover by holding the scanner with one thumb placing on the feeder and another thumb placing on the cover. Carefully and firmly press your thumb into the feeder and then raise the cover. This will cause the top of the scanner to release from the bottom of the scanner.
2. Remove the item.

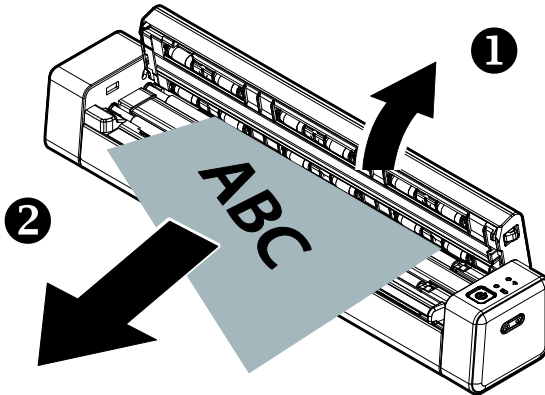

3. Close the cover and reinsert the item to rescan.

8.3 Questions and Answers

Question:	Why does not my scanner turn on?
Answer:	Ensure the USB cable is securely connected to the scanner to the USB slot in your computer.

Question:	Why doesn't my computer recognize my scanner when it's connected via USB cable?
Answer:	Make sure the cable connection is correct and secure. Restart the computer if necessary.

Question:	Should the scanner feel warm to the touch?
Answer:	It is normal for the scanner to emit a small amount of heat after prolonged use. However, if there are strange odors coming from the scanner or the scanner feels a little bit hot to the touch, turn the scanner off immediately.

Question:	Why there are strange lines on the scanned document?
Answer:	Please check the following: <ol style="list-style-type: none">1. Are there scratches on the original or is the original clean ?2. Remove any stains or dust from the original before scanning.3. Clean the rollers and glass with the included cleaning cloth.

Question:	Why does my scanned image always come out too dark?
Answer:	<ol style="list-style-type: none">1. Please adjust the screen settings to sRGB.2. Please adjust the brightness settings on the screen from application software.

Question:	When I choose optical resolution to be 600 dpi, the "auto crop" and "deskew" functions will be disabled.
Answer:	Since to perform auto crop and deskew consumes great deal of system memory, it is suggested if you wish to perform "auto crop" and "deskew" functions, please choose your optical resolution to be smaller than 600 dpi to prevent a error message.

Question:	What should I do if the status indicator blinks rapidly and no scan is possible?
Answer:	Check the following: <ul style="list-style-type: none">● Is there a jam in the feeder? Power the scanner off and then on again to continue the sheet feed. If the item is still jammed, open the cover and gently pull out the item.● Is the cover open? Make sure the cover is snapped firmly in place.● Did you insert the next original before the scanning process of the previous one was completed? Turn the scanner off and back on and try again. Make sure that you scan the next original only after the scanning process of the previous one has completed.● Does the length of the original exceed the maximum acceptable size?

Wi-Fi Mode:

Question:	Why can't I see the Scanner's Wi-Fi Network name (SSID) [SSID]?
Answer:	Make sure you have slid the [Wi-Fi] switch to the [On] position and the Wi-Fi indicator light is lit on the LCD screen. If Wi-Fi Access Point is still in countdown mode, wait until the blue Wi-Fi indicator light turned solidly on.
Question:	Will the battery power get used up faster when Wi-Fi mode is on?
Answer:	Yes. When Wi-Fi mode is on, the scanner does automatically turn off like it does normally. Therefore, it is recommended to turn off the Wi-Fi mode when images have been downloaded onto your computer.
Question:	Why can't I connect to my email or other web related locations/programs after disconnecting from the scanner Wi-Fi network?
Answer:	To resume your normal Wi-Fi connection, be sure to re-connect your computer, tablet or phone to your usual local Wi-Fi network when you are finished with your scanner connection.

8.4 Technical Service

Before contact Avision, please prepare the following information:

- Scanner serial & revision number (located on the bottom of the scanner);

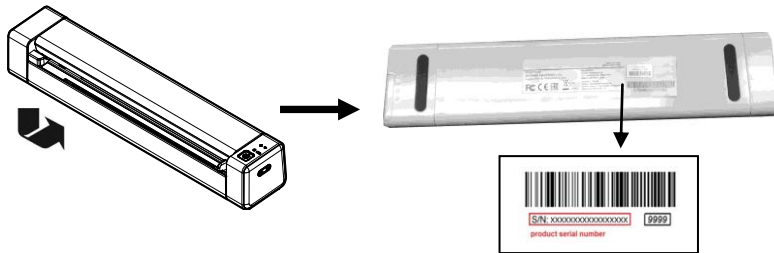

- Hardware configuration (e.g., your host CPU type, RAM size, free disk space, display card, interface card);
- The name and version of your scanning software application;
- The version of your scanner driver.

Please call us at:

Headquarter

Avision Inc.

No. 20, Creation Road I, Science-Based Industrial Park,
Hsinchu 300, Taiwan, ROC

TEL: +886 (3) 578-2388

FAX: +886 (3) 577-7017

E-MAIL: service@avision.com.tw

Web Site: <http://www.avision.com.tw>

US and Canada Area

Avision Labs, Inc.

6815 Mowry Ave., Newark CA 94560, USA

TEL: +1 (510) 739-2369

FAX: +1 (510) 739-6060

E-MAIL: support@avision-labs.com

Web Site: <http://www.avision.com>

China Area

Shanghai Technical Support Center

7A, No.1010, Kaixuan Road, Shanghai 200052 P.R.C.

TEL :+86-21-62816680

FAX :+86-21-62818856

E-MAIL :sales@avision.net.cn

Web Site:<http://www.avision.com.cn>

Europe Area

Avision Europe GmbH

Bischofstr. 101 D-47809 Krefeld Germany

TEL: +49-2151-56981-40

FAX: +49-2151-56981-42

E-MAIL: info@avision-europe.com

Web Site: <http://www.avision.de>

Espaço Brasil

Avision Brasil Ltda.

Avenida Jabaquara, 2958 - Cj. 75 - Mirandópolis -

CEP: 04046-500 - São Paulo, Brasil

TEL: +55-11-2925-5025

E-MAIL: suporte@avision.com.br

Web Site: <http://www.avision.com.br>

9. Specifications

All specifications are subject to change without notice.

Model Number :	FF-2111B (simplex scanner)
Image Technology:	Contact Image Sensor (CIS)
Optical Resolution:	600 dpi
Scanning Modes:	Black & White/Gray/Color
Max. Paper Size:	8.5" x 14" (width x length)
Min. Paper Size:	2.0" x 2.9" (width x length)
Paper Weight:	52 ~ 105 g/m ²
ID Card Thickness:	Up to 0.76 mm
Interface:	USB Type-C port Wireless 802.11 b/g/n
Power:	Battery (Li-ion18650, 3.6V/2750mAh)
Operating Temperature:	10°C ~ 35°C
Humidity:	15%~85% RH
Dimensions: (HxWxD)	294 x 67 x 47 mm
Weight:	Approx. 480g

Wi-Fi Specifications:

Model: CF-811AC

Main Chipset	RTL8811CU
Host interface	USB 2.0
Frequency Range	2.4GHz&5.8GHz
Wi-Fi Standard	IEEE 802.11a IEEE 802.11b IEEE 802.11g IEEE 802.11n IEEE 802.11ac
Transmit Speed	11b : 1/2/5.5/11Mbps 11g : 6/9/12/18/24/36/48/54Mbps 11n : 200Mbps 11ac : 433Mbps
Security	WPA-PSK/WPA2-PSK WPA/WPA2 WEP
Operating System	Windows XP/Vista/7/8/8.1/10 (32/64 bit) macOS 10.6 ~10.15